



Inkl. Kressegment-Fräser für bessere Oberflächengüten und kürzere Bearbeitungszeiten
Incl. Circle Segment End Mills for Better Surface Finish and Shorter Machining Time

FRANKEN
Turbine

Fräser für die Impeller- und Schaufelblattbearbeitung
Milling Cutters for Machining of Impellers and Turbine Blades



Der **FRANKEN Formfräser „Pagode“** wird zum Schlichten von Schaufelfußnuten und Schaufelfußprofilen eines Turbinenrotors eingesetzt. Die neuartige Spannutegeometrie ermöglicht eine höhere Schneidenanzahl und einen höheren Fräsvorschub gegenüber dem Tannenbaumfräser. Das führt zu einer spürbaren Reduzierung der Bearbeitungszeit bei gleichzeitiger Verdoppelung der Standzeit.

FRANKEN Formfräser „Pagode“ werden entsprechend den Kundenbedürfnissen individuell entwickelt und hergestellt.

The **FRANKEN “Pagode” form milling cutter** is used for finishing the grooves of blade roots and for blade root profiles of turbine rotors. The innovative geometry of the chip flute enables more cutting teeth and an increase of the milling feed compared to a fir tree cutter. The result is a significant reduction of machining time while doubling tool life.

FRANKEN “Pagode” form milling cutters are individually developed and produced according to customer requirements.

FRANKEN, der Pionier bei Kreissegment-Fräsern, vervollständigt sein Fräserprogramm für die Impeller- und Schaufelblattbearbeitung um neue Schrupp- und Schlichtausführungen mit Innenkühlung und Eckenradius „ER“.

Die Schruppausführung ermöglicht es, auch an komplexen Bauteilen und Schaufeln ein konstantes Aufmaß für die nachfolgende Schlichtbearbeitung mit einem weiteren Kreissegment-Fräser herzustellen und damit die Vorschlichtbearbeitung einzusparen. In dieser neuartigen Kombination aus Schruppen mit Vorschlichten und anschließendem Schlichten sind Zeiteinsparungen bei der Fräsbearbeitung von bis zu 50% möglich. Gleichzeitig werden signifikante Verbesserungen der Oberflächen erzielt, was zum Beispiel bei Schaufelblättern aufwändige Nacharbeit durch Entfernung von Bearbeitungsübergängen vermeidet und die Maßhaltigkeit und Formtreue wesentlich verbessert.

Das Fräserprogramm FRANKEN Turbine umfasst Vollhartmetall-Werkzeuge zur Vor- und Fertigbearbeitung von Bauteilen an Turbinen oder anderen komplexen 5-Achs-Bauteilen.

Die beiden neuen, konischen FRANKEN Turbine Torusfräser ergänzen das bisherige Fräserprogramm um weitere Ausführungen mit innerer Kühlschmierstoff-Zufuhr. Diese ermöglicht eine bessere Spanabfuhr und verbessert dadurch die Prozesssicherheit und Standzeiten. Dank einer Schruppverzahnung in Verbindung mit ungleicher Teilung eignen sie sich ideal zum vibrationsarmen Vorfräsen von Impellern, Schaufelblättern oder Integrated Blade Rotors (IBR).

Schneidstoff, Geometrie und Beschichtung aller Fräswerkzeuge sind auf schwer zerspanbare Werkstoffe, wie z.B. Titanlegierungen oder Inconel, ausgerichtet.

Fräswerkzeuge der Produktlinien FRANKEN Turbine und FRANKEN Expert sind auf Anfrage auch in kundenspezifischen Ausführungen erhältlich. Wenden Sie sich hierzu bitte an den für Sie zuständigen Vertriebspartner.

FRANKEN, the pioneer in circle segment end mills, completes the range of milling cutters for machining of impellers and turbine blades with new roughing and finishing versions with internal cooling and corner radius “ER”.

The roughing design makes it possible to produce a constant machining allowance with a circle segment end mill for subsequent finishing even on complex components and turbine blades, thus making the pre-finishing operation redundant. This innovative combination of roughing with pre-finishing and subsequent finishing enables time savings in milling operations of up to 50%. At the same time, significant improvements of the surface quality are achieved, which is the case with turbine blades, for example, where time-consuming rework by removal of machining transitions is no longer necessary and the dimensional precision and form accuracy can be substantially improved.

The FRANKEN Turbine milling cutter range comprises solid carbide tools for the roughing and finishing of components on turbines or other complex 5-axis components.

The two new tapered FRANKEN Turbine torus end mills complement the previous range of milling cutters with additional versions which integrate internal coolant supply. These additions facilitate chip evacuation and thus improve process reliability and tool life. Thanks to a roughing geometry combined with variable spacing they are ideal for low-vibration pre-milling of impellers, turbine blades or integrated blade rotors (IBR).

Cutting material, geometry and coating of all milling tools are geared towards materials which are difficult to machine, such as titanium alloys or Inconel.

Milling tools of the product lines FRANKEN Turbine and FRANKEN Expert are also available in customer-specific versions on request. Please contact your responsible sales partner for details.

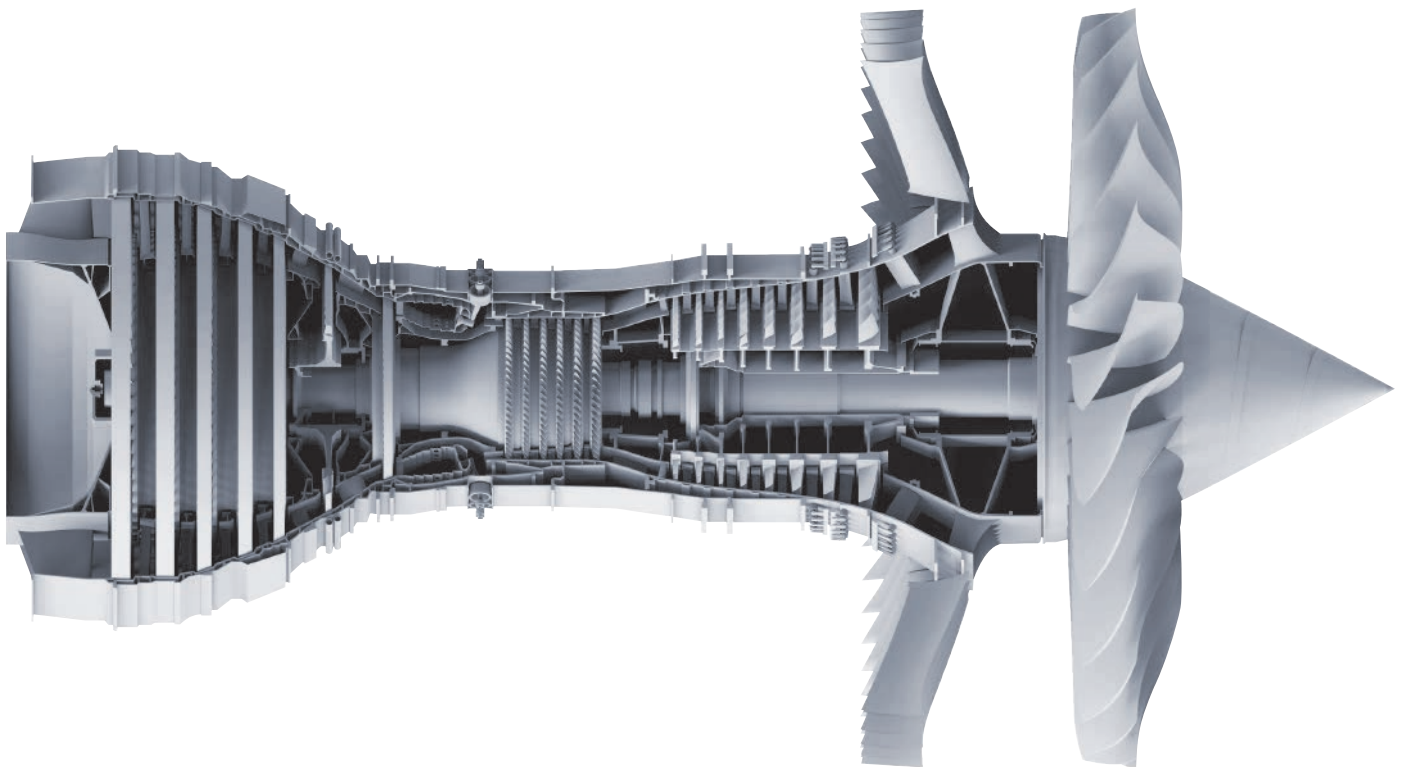

Wegweiser

Bitte beachten:

Die Eignung ist folgendermaßen gekennzeichnet:

- = sehr gut geeignet
- = gut geeignet

Die zugehörigen Schnittwerte sind auf den Seiten 9 bis 51 zu finden.

Product finder

Please note:

The suitability is indicated as follows:

- = very suitable
- = suitable

Please find the cutting conditions on pages 9 up to 51.

Einsatzgebiete – Material Applications – material		Material-Beispiele Material examples	Material-Nummern Material numbers
P	Stahlwerkstoffe Steel materials		
	1.1 Kaltfließpressstähle, Baustähle, Automatenstähle, u.a.	Cold-extrusion steels, Construction steels, Free-cutting steels, etc.	≤ 600 N/mm ² Cq15 1.1132 S235JR (St37-2) 1.0037 10SPb20 1.0722
	2.1 Baustähle, Einsatzstähle, Stahlguss, u.a.	Construction steels, Case-hardened steels, Steel castings, etc.	≤ 800 N/mm ² E360 (St70-2) 1.0070 16MnCr5 1.7131 GS-25CrMo4 1.7218
	3.1 Einsatzstähle, Vergütungsstähle, Kaltarbeitsstähle, u.a.	Case-hardened steels, Heat-treatable steels, Cold work steels, etc.	≤ 1000 N/mm ² 20MoCr3 1.7320 42CrMo4 1.7225 102Cr6 1.2067 50CrMo4 1.7228
	4.1 Vergütungsstähle, Kaltarbeitsstähle, Nitrierstähle, u.a.	Heat-treatable steels, Cold work steels, Nitriding steels, etc.	≤ 1200 N/mm ² X45NiCrMo4 1.2767 31CrMo12 1.8515
5.1 Hochlegierte Stähle, Kaltarbeitsstähle, Warmarbeitsstähle, u.a.	High-alloyed steels, Cold work steels, Hot work steels, etc.	≤ 1400 N/mm ² X38CrMoV5-3 1.2367 X100CrMoV8-1-1 1.2990 X40CrMoV5-1 1.2344	
M	Nichtrostende Stahlwerkstoffe Stainless steel materials		
	1.1 Ferritisch, martensitisch	Ferritic, martensitic	≤ 950 N/mm ² X2CrTi12 1.4512
	2.1 Austenitisch	Austenitic	≤ 950 N/mm ² X6CrNiMoTi17-12-2 1.4571
	3.1 Austenitisch-ferritisch (Duplex)	Austenitic-ferritic (Duplex)	≤ 1100 N/mm ² X2CrNiMoN22-5-3 1.4462
4.1 Austenitisch-ferritisch hitzebeständig (Super Duplex)	Austenitic-ferritic heat-resistant (Super Duplex)	≤ 1250 N/mm ² X2CrNiMoN25-7-4 1.4410	
K	Gusswerkstoffe Cast materials		
	1.1 Gusseisen mit Lamellengrafit (GJL)	Cast iron with lamellar graphite (GJL)	100-250 N/mm ² EN-GJL-200 (GG20) EN-JL-1030
	2.1 Gusseisen mit Kugelgrafit (GJS)	Cast iron with nodular graphite (GJS)	250-450 N/mm ² EN-GJL-300 (GG30) EN-JL-1050
	2.2 Gusseisen mit Kugelgrafit (GJS)	Cast iron with nodular graphite (GJS)	350-500 N/mm ² EN-GJS-400-15 (GGG40) EN-JS-1030
	3.1 Gusseisen mit Vermiculargrafit (GJV)	Cast iron with vermicular graphite (GJV)	500-900 N/mm ² EN-GJS-700-2 (GGG70) EN-JS-1070
	3.2 Gusseisen mit Vermiculargrafit (GJV)	Cast iron with vermicular graphite (GJV)	300-400 N/mm ² GJV 300
	4.1 Temperguss (GTMW, GTMB)	Malleable cast iron (GTMW, GTMB)	400-500 N/mm ² GJV 450
4.2 Temperguss (GTMW, GTMB)	Malleable cast iron (GTMW, GTMB)	250-500 N/mm ² EN-GJMW-350-4 (GTW-35) EN-JM-1010	
5.0 Temperguss (GTMW, GTMB)	Malleable cast iron (GTMW, GTMB)	500-800 N/mm ² EN-GJMB-450-6 (GTS-45) EN-JM-1140	
N	Nichteisenwerkstoffe Non-ferrous materials		
	1.1 Aluminium-Legierungen	Aluminium alloys	
	1.2 Aluminium-Knetlegierungen	Wrought aluminium alloys	≤ 200 N/mm ² EN AW-AMn1 EN AW-3103
	1.3 Aluminium-Knetlegierungen	Wrought aluminium alloys	≤ 350 N/mm ² EN AW-AMgSi EN AW-6060
	1.4 Aluminium-Knetlegierungen	Wrought aluminium alloys	≤ 550 N/mm ² EN AW-AlZn5Mg3Cu EN AW-7022
	1.5 Aluminium-Gusslegierungen	Aluminium cast alloys	Si ≤ 7% EN AC-AMg5 EN AC-51300
	1.6 Aluminium-Gusslegierungen	Aluminium cast alloys	7% < Si ≤ 12% EN AC-AISi9Cu3 EN AC-46500
	12% < Si ≤ 17%	Aluminium cast alloys	GD-AISi17Cu4FeMg
	2.1 Reinkupfer, niedriglegiertes Kupfer	Pure copper, low-alloyed copper	≤ 400 N/mm ² E-Cu 57 EN CW 004 A
	2.2 Kupfer-Zink-Legierungen (Messing, langspanend)	Copper-zinc alloys (brass, long-chipping)	≤ 550 N/mm ² CuZn37 (Ms63) EN CW 508 L
	2.3 Kupfer-Zink-Legierungen (Messing, kurzspanend)	Copper-zinc alloys (brass, short-chipping)	≤ 550 N/mm ² CuZn36Pb3 (Ms58) EN CW 603 N
	2.4 Kupfer-Aluminium-Legierungen (Alubronze, langspanend)	Copper-aluminium alloys (alu bronze, long-chipping)	≤ 800 N/mm ² CuAl10Ni5Fe4 EN CW 307 G
	2.5 Kupfer-Zinn-Legierungen (Zinnbronze, langspanend)	Copper-tin alloys (tin bronze, long-chipping)	≤ 700 N/mm ² CuSn8P EN CW 459 K
	2.6 Kupfer-Zinn-Legierungen (Zinnbronze, kurzspanend)	Copper-tin alloys (tin bronze, short-chipping)	≤ 400 N/mm ² CuSn7 ZnPb (Rg7) 2.1090
	2.7 Kupfer-Sonderlegierungen	Special copper alloys	≤ 600 N/mm ² (AMPCO® 8)
	2.8 Kupfer-Sonderlegierungen	Special copper alloys	≤ 1400 N/mm ² (AMPCO® 45)
3.1 Magnesium-Knetlegierungen	Magnesium wrought alloys	≤ 500 N/mm ² MgAl6Zn 3.5612	
3.2 Magnesium-Gusslegierungen	Magnesium cast alloys	≤ 500 N/mm ² EN-MCMgAl9Zn1 EN-MC21120	
S	Kunststoffe Synthetics		
	4.1 Duroplaste (kurzspanend)	Duroplastics (short-chipping)	Bakelit, Pertinax
	4.2 Thermoplaste (langspanend)	Thermoplastics (long-chipping)	PMMA, POM, PVC
	4.3 Faserverstärkte Kunststoffe (Faseranteil ≤ 30%)	Fibre-reinforced synthetics (fibre content ≤ 30%)	GFK, CFK, AFK
	4.4 Faserverstärkte Kunststoffe (Faseranteil > 30%)	Fibre-reinforced synthetics (fibre content > 30%)	GFK, CFK, AFK
	5.1 Besondere Werkstoffe	Special materials	C 8000
	5.2 Wolfram-Kupfer-Legierungen	Tungsten-copper alloys	W-Cu 80/20
	5.3 Verbundwerkstoffe	Composite materials	HyLite, Alucobond
H	Spezialwerkstoffe Special materials		
	1.1 Titan-Legierungen	Titanium alloys	
	1.2 Reintitan	Pure titanium	≤ 450 N/mm ² Ti1 3.7025
	1.3 Titan-Legierungen	Titanium alloys	≤ 900 N/mm ² TiAl6V4 3.7165
	1.3 Titan-Legierungen	Titanium alloys	≤ 1250 N/mm ² TiAl4Mo4Sn2 3.7185
	2.1 Nickel-, Kobalt- und Eisen-Legierungen	Nickel alloys, cobalt alloys and iron alloys	
	2.2 Reinnickel	Pure nickel	≤ 600 N/mm ² Ni 99.6 2.4060
	2.3 Nickel-Basis-Legierungen	Nickel-base alloys	≤ 1000 N/mm ² Monel 400 2.4360
	2.4 Nickel-Basis-Legierungen	Nickel-base alloys	≤ 1600 N/mm ² Inconel 718 2.4668
	2.5 Kobalt-Basis-Legierungen	Cobalt-base alloys	≤ 1000 N/mm ² Udimet 605
2.6 Eisen-Basis-Legierungen	Iron-base alloys	≤ 1600 N/mm ² Haynes 25 2.4964	
2.6 Eisen-Basis-Legierungen	Iron-base alloys	≤ 1500 N/mm ² Incoloy 800 1.4958	
H	Harte Werkstoffe Hard materials		
	1.1 Hochfeste Stähle, gehärtete Stähle, Hartguss	High strength steels, hardened steels, hard castings	44 - 50 HRC Weldox 1100
	1.2 Hochfeste Stähle, gehärtete Stähle, Hartguss	High strength steels, hardened steels, hard castings	50 - 55 HRC Hardox 550
	1.3 Hochfeste Stähle, gehärtete Stähle, Hartguss	High strength steels, hardened steels, hard castings	55 - 60 HRC Armax 600T
	1.4 Hochfeste Stähle, gehärtete Stähle, Hartguss	High strength steels, hardened steels, hard castings	60 - 63 HRC Ferro-Titanit
	1.5 Hochfeste Stähle, gehärtete Stähle, Hartguss	High strength steels, hardened steels, hard castings	63 - 66 HRC HSSE

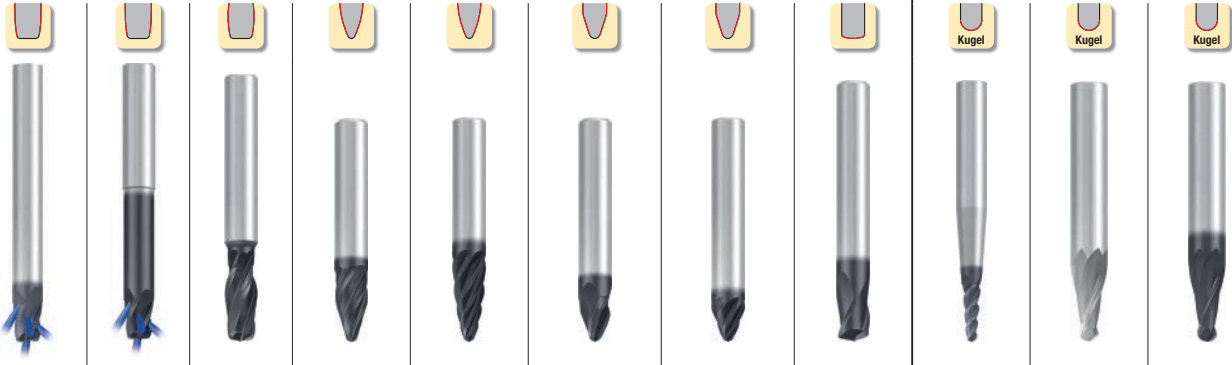

Allround								Allround			Z (Flutes)
NR	N							NR	NF		
fein · fine	N							fein · fine	fein · fine		
ø8 - 16 mm	ø8 - 16 mm	r ₂ = 50 mm	r ₂ = 75 - 95 mm	ø10 - 16 mm	α _{1/2} = 12,5 - 70° r ₂ = 200 - 1500 mm	α _{1/2} = 12,5 - 70° r ₂ = 200 - 1000 mm	r ₂ = 6 - 25 mm	α _{1/2} = 4° r = 2 - 4 mm	α _{1/2} = 3 - 8° r = 0,5 - 2 mm	α _{1/2} = 3 - 8° r = 0,5 - 2 mm	
4	4	4	3 - 4	6	2 - 3	4 - 6	3	3	2	2	
3552LZ	3554LZ	3542L	3538L	3539L	3540L	3541L	3544L	3546L	3446 / 3447	3446L	
-	-	-	-	-	-	-	-	-	-	-	
8	10	12	14	16	18	20	22	24	26	26	Seite · Page
9	11	13	15	17	19	21	23	25	27	27	V _c / f _z

■	■	■	■	■	■	■	■	■	■	■	1.1
■	■	■	■	■	■	■	■	■	■	■	2.1
■	■	■	■	■	■	■	■	■	■	■	3.1
■	■	■	■	■	■	■	■	■	■	□	4.1
■	■	■	■	■	■	■	■	■	■	□	5.1
■	■	■	■	■	■	■	■	■	■	■	1.1
■	■	■	■	■	■	■	■	■	■	■	2.1
■	■	□	□	□	□	□	□	■	■	■	3.1
■	■	□	□	□	□	□	□	■	■	■	4.1
■	■	■	■	■	■	■	■	■	■	■	1.1
■	■	■	■	■	■	■	■	■	■	■	1.2
■	■	■	■	■	■	■	■	■	■	■	2.1
■	■	■	■	■	■	■	■	■	■	■	2.2
■	■	■	■	■	■	■	■	■	■	■	2.3
■	■	■	■	■	■	■	■	■	■	■	2.4
■	■	■	■	■	■	■	■	■	■	■	2.5
■	■	■	■	■	■	■	■	■	■	■	2.6
■	■	■	■	■	■	■	■	■	■	■	2.7
■	■	■	■	■	■	■	■	■	■	■	2.8
■	■	■	■	■	■	■	■	■	■	■	3.1
■	■	■	■	■	■	■	■	■	■	■	3.2
■	■	■	■	■	■	■	■	■	■	■	4.1
■	■	■	■	■	■	■	■	■	■	■	4.2
■	■	■	■	■	■	■	■	■	■	■	4.3
■	■	■	■	■	■	■	■	■	■	■	4.4
■	■	■	■	■	■	■	■	■	■	■	5.1
■	■	■	■	■	■	■	■	■	■	■	5.2
■	■	■	■	■	■	■	■	■	■	■	5.3
■	■	■	■	■	■	■	■	■	■	■	1.1
■	■	■	■	■	■	■	■	■	■	■	1.2
■	■	■	■	■	■	■	■	■	■	□	1.3
■	■	■	■	■	■	■	■	■	■	■	2.1
■	■	■	■	■	■	■	■	■	■	■	2.2
■	■	■	■	■	■	■	■	■	■	■	2.3
■	■	■	■	■	■	■	■	■	■	■	2.4
■	■	■	■	■	■	■	■	■	■	■	2.5
■	■	■	■	■	■	■	■	■	■	■	2.6
■	■	■	■	■	■	■	■	■	■	■	1.1
■	■	■	■	■	■	■	■	■	■	■	1.2
■	■	■	■	■	■	■	■	■	■	■	1.3
■	■	■	■	■	■	■	■	■	■	■	1.4
■	■	■	■	■	■	■	■	■	■	■	1.5

■ = sehr gut geeignet · very suitable
□ = gut geeignet · suitable



Allround

Hard materials

N

H

	$\alpha/2 = 3 - 8^\circ$ $r = 1,5 - 3 \text{ mm}$	$\alpha/2 = 3 - 8^\circ$ $r = 1,5 - 3 \text{ mm}$	$\alpha/2 = 3 - 17,5^\circ$ $r = 0,5 - 3 \text{ mm}$	$\alpha/2 = 3 - 17,5^\circ$ $r = 0,5 - 3 \text{ mm}$	$\alpha/2 = 4^\circ$ $r = 2 - 4 \text{ mm}$	$\alpha/2 = 4^\circ$ $r = 2 - 4 \text{ mm}$	$\alpha/2 = 4^\circ$ $r = 3 - 8 \text{ mm}$	$\emptyset 3 - 12 \text{ mm}$	$\emptyset 6 - 12 \text{ mm}$
Z (Flutes)	2	2	2	2	3	3/6	3/6	4	4
	3442 / 3443	3442L	3440 / 3441	3440L	3550L	3548L	2679A	2834A	2842A
Seite · Page	28	28	30	30	32	34	36	38	40
v_c / f_z	29	29	31	31	33	35	37	39	41

P	1.1	■	■	■	■	■	■	□	□
	2.1	■	■	■	■	■	■	□	□
	3.1	■	■	■	■	■	■	■	■
	4.1	□	□	□	□	■	■	■	■
	5.1	□	□	□	□	■	■	■	■
M	1.1	■	■	■	■	■	■	■	■
	2.1	■	■	■	■	■	■	■	■
	3.1	■	■	■	■	■	■	■	■
	4.1	■	■	■	■	■	■	■	■
K	1.1	■	■	■	■	■	■	■	■
	1.2	■	■	■	■	■	■	■	■
	2.1	■	■	■	■	■	■	■	■
	2.2	■	■	■	■	■	■	■	■
	3.1	□	□	□	□	■	■	■	■
	3.2	□	□	□	□	■	■	■	■
	4.1	□	□	□	□	■	■	■	■
	4.2	□	□	□	□	■	■	■	■
N	1.1	■	■	■	■	■	■	■	■
	1.2	■	■	■	■	■	■	■	■
	1.3	■	■	■	■	■	■	■	■
	1.4	■	■	■	■	■	■	■	■
	1.5	□	□	□	□	■	■	■	■
	1.6	□	□	□	□	■	■	■	■
	2.1	■	■	■	■	■	■	■	■
	2.2	■	■	■	■	■	■	□	□
	2.3	■	■	■	■	■	■	■	■
	2.4	■	■	■	■	■	■	□	□
	2.5	■	■	■	■	■	■	□	□
	2.6	■	■	■	■	■	■	■	■
	2.7	□	□	□	□	■	■	■	■
	2.8	□	□	□	□	■	■	■	■
	3.1	■	■	■	■	■	■	■	■
	3.2	■	■	■	■	■	■	■	■
4.1	■	■	■	■	■	■	■	■	
4.2	■	■	■	■	■	■	■	■	
4.3	■	■	■	■	■	■	■	■	
4.4	■	■	■	■	■	■	■	■	
5.1	■	■	■	■	■	■	■	■	
5.2	■	■	■	■	■	■	■	■	
5.3	■	■	■	■	■	■	■	■	
S	1.1	■	■	■	■	■	■	■	■
	1.2	■	■	■	■	■	■	■	■
	1.3	□	□	□	□	■	■	■	■
	2.1	■	■	■	■	■	■	■	■
	2.2	■	■	■	■	■	■	■	■
	2.3	□	□	□	□	■	■	■	■
	2.4	□	□	□	□	■	■	■	■
2.5	□	□	□	□	■	■	■	■	
2.6	□	□	□	□	■	■	■	■	
H	1.1	■	■	■	■	■	■	■	■
	1.2	■	■	■	■	■	■	■	■
	1.3	■	■	■	■	■	■	■	■
	1.4	■	■	■	■	■	■	■	■
	1.5	■	■	■	■	■	■	■	■



Allround

N		NR <small>fein · fine</small>		N					
ø4 - 10 mm	$\alpha/2=3^\circ$ ø6,5 - 8,5 mm	$\alpha/2=3^\circ$ ø5 - 6 mm	$\alpha/2=3-8^\circ$ ød ₁ =3 - 5 mm	$\alpha/2=3-8^\circ$ ød ₁ =3 - 5 mm	$\alpha/2=8^\circ$ ød ₁ =8 - 11 mm	$\alpha/2=8^\circ$ ød ₁ =9 - 19 mm	ød ₁ =8 - 16 mm	Z (Flutes)	
4	4	3	2	2	7 - 9	5 - 13	5 - 9		
2564L	-	-	3444 / 3445	3444L	2677AZ	2678AZ	2676AZ		
-	3534LZ	3532LZ	-	-	-	-	-		
42	44	44	46	46	48	48	50	Seite · Page	
43	45	45	47	47	49	49	51	v_c / f_z	
								P	
■	■	■		■	■	■	■		1.1
■	■	■		■	■	■	■		2.1
■	■	■		■	■	■	■		3.1
■	■	■		□	■	■	■		4.1
■	■	■		□	■	■	■	5.1	
								M	
■	■	■		■	■	■	■		1.1
■	■	■		■	■	■	■		2.1
■	■	■		■	■	■	■		3.1
								K	
□				■	■	■	■		1.1
□				■	■	■	■		1.2
□				■	■	■	■		2.1
□				■	■	■	■		2.2
□				□	■	■	■		3.1
□				□	■	■	■		3.2
□				□	■	■	■	4.1	
□				□	■	■	■	4.2	
								N	
	■	■	■	■					1.1
	■	■	■	■					1.2
	■	■	■	■					1.3
				■					1.4
				□					1.5
									1.6
■				■	■	■	■		2.1
■				■	■	■	■		2.2
■				■	■	■	■		2.3
■				■	■	■	■	2.4	
■				■	■	■	■	2.5	
■				■	■	■	■	2.6	
■				□	■	■	■	2.7	
■				□	■	■	■	2.8	
								S	
				■					3.1
				■					3.2
			■	■					4.1
			■	■					4.2
				■					4.3
				■					4.4
								H	
				■					5.1
				■					5.2
				■					5.3
■	■	■		■	■	■	■		1.1
■	■	■		■	■	■	■		1.2
■	■	■		□	■	■	■	1.3	
■	■	■		■	■	■	■	2.1	
■	■	■		■	■	■	■	2.2	
■	■	■		■	■	■	■	2.3	
■	■	■		■	■	■	■	2.4	
■	■	■		□	■	■	■	2.5	
■	■	■		□	■	■	■	2.6	
□								1.1	
□								1.2	
□								1.3	
								1.4	
								1.5	

■ = sehr gut geeignet · very suitable
□ = gut geeignet · suitable

- Hochleistungswerkzeug
- Mit 4 Schneiden
- Ungleiche Teilung
- Vibrationsarme Bearbeitung
- Hocheffiziente Schruppbearbeitung
- High performance tool
- With 4 flutes
- Variable spacing
- Low-vibration machining
- Highly efficient roughing

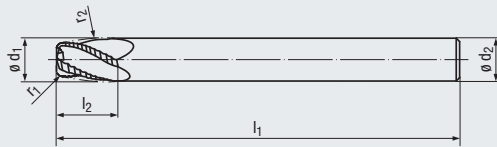
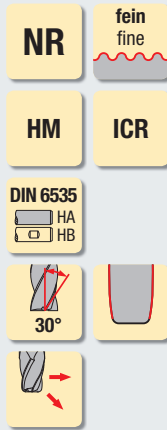

Tropfenform – ER
Oval Form – ER



Allround

Beschichtung · Coating

Einsatzgebiete – Material (siehe Seite 4)

- Speziell für hochfeste Werkstoffe geeignet
- Auch für Nickel-Basis-Legierungen einsetzbar
- Für die Zerspanung von Titan-Legierungen geeignet
- Einsatz in allen Turbinenwerkstoffen möglich
- Optimiert zur Vorbearbeitung von Impellern und Integrated Bladed Rotors (IBR) aus Aluminium, Titan und Inconel

Applications – material (see page 4)

- Especially suitable for high-strength materials
- Also suitable in nickel-base alloys
- For the machining of titanium alloys
- Suitable in all turbine materials
- Optimised for pre-finishing Impellers and Integrated Bladed Rotors (IBR) made from aluminium, titanium and Inconel

ALCR

- P** 1.1-5.1
- M** 1.1-4.1
- N** 1.1-1.3
- S** 1.1-1.3
- S** 2.2-2.6

Bestell-Code · Order code

3552LZ

d ₁	r ₁	r ₂	l ₂	l ₁	∅ d ₂ h6	Z (Flutes)	Dimens.- Code			
8	1	40	12	80	8	4	.08040A	●		
10	1,5	45	12	95	10	4	.10045A	●		
12	2	50	14	100	12	4	.12050A	●		
16	2	60	18	128	16	4	.16060A	●		

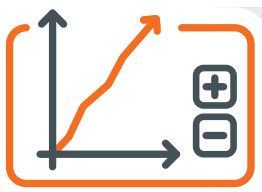

Wirtschaftlichkeitsberechnung für Kreissegment-Fräser

Economical calculation for circle segment end mills

www.frankenexpert.com

Kreissegment-Fräser mit Tropfenform – ER
Circle segment end mills with oval form – ER

NR

Gültig für · Valid for
3552LZ

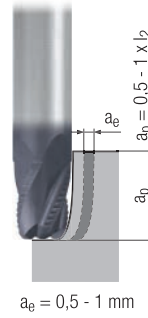
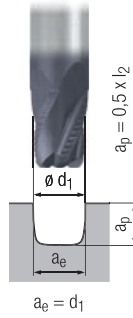

	V_c [m/min]	f_z [mm]	V_c [m/min]	f_z [mm]					
P	1.1	100	$0,004 \times d_1$	140	$0,005 \times d_1$		■	□	■
	2.1	90	$0,004 \times d_1$	130	$0,004 \times d_1$		■	□	■
	3.1	90	$0,003 \times d_1$	120	$0,004 \times d_1$		■	□	■
	4.1	80	$0,002 \times d_1$	110	$0,003 \times d_1$		■	□	■
	5.1	70	$0,002 \times d_1$	100	$0,003 \times d_1$		■	□	■
M	1.1	80	$0,004 \times d_1$	100	$0,005 \times d_1$				■
	2.1	70	$0,003 \times d_1$	80	$0,004 \times d_1$				■
	3.1	60	$0,002 \times d_1$	70	$0,003 \times d_1$				■
	4.1	60	$0,002 \times d_1$	70	$0,003 \times d_1$				■
K	1.1								
	1.2								
	2.1								
	2.2								
	3.1								
	3.2								
N	1.1	280	$0,006 \times d_1$	400	$0,006 \times d_1$				■
	1.2	200	$0,005 \times d_1$	280	$0,005 \times d_1$				■
	1.3	140	$0,004 \times d_1$	200	$0,004 \times d_1$				■
	1.4								
	1.5								
	1.6								
	2.1								
	2.2								
	2.3								
	2.4								
	2.5								
	2.6								
	2.7								
	2.8								
	3.1								
3.2									
4.1									
4.2									
4.3									
4.4									
5.1									
5.2									
5.3									
S	1.1	90	$0,002 \times d_1$	120	$0,004 \times d_1$				■
	1.2	75	$0,002 \times d_1$	100	$0,003 \times d_1$				■
	1.3	45	$0,002 \times d_1$	60	$0,002 \times d_1$				■
	2.1								
	2.2	25	$0,002 \times d_1$	30	$0,002 \times d_1$				■
	2.3	25	$0,002 \times d_1$	30	$0,002 \times d_1$				■
2.4	25	$0,002 \times d_1$	30	$0,002 \times d_1$				■	
2.5	15	$0,002 \times d_1$	20	$0,002 \times d_1$				■	
2.6	25	$0,002 \times d_1$	30	$0,002 \times d_1$				■	
H	1.1								
	1.2								
	1.3								
	1.4								
	1.5								

v_c = Schnittgeschwindigkeit · Cutting speed
 f_z = Vorschub pro Zahn · Feed per tooth

■ = sehr gut geeignet · very suitable
□ = gut geeignet · suitable

- Hochleistungswerkzeug
- Mit 4 Schneiden
- Ungleiche Teilung
- Vibrationsarme Bearbeitung
- Hocheffiziente Schlichtbearbeitung
- Formtoleranz $\pm 0,01$ mm

- High performance tool
- With 4 flutes
- Variable spacing
- Low-vibration machining
- Highly efficient finishing
- Form tolerance ± 0.01 mm

N

HM **ICR**

DIN 6535
HA
HB

Form
 $\pm 0,01$

30°

Tropfenform – ER
Oval Form – ER



Allround

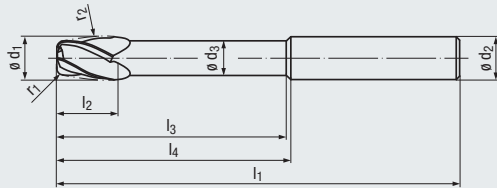
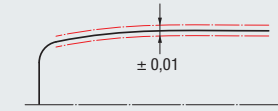

Beschichtung · Coating

Einsatzgebiete – Material (siehe Seite 4)

- Speziell für hochfeste Werkstoffe geeignet
- Auch für Nickel-Basis-Legierungen einsetzbar
- Für die Zerspaltung von Titan-Legierungen geeignet
- Einsatz in allen Turbinenwerkstoffen möglich
- Optimiert zur Fertigbearbeitung von Impellern und Integrated Bladed Rotors (IBR) aus Aluminium, Titan und Inconel

Applications – material (see page 4)

- Especially suitable for high-strength materials
- Also suitable in nickel-base alloys
- For the machining of titanium alloys
- Suitable in all turbine materials
- Optimised for finishing Impellers and Integrated Bladed Rotors (IBR) made from aluminium, titanium and Inconel

ALCR

- P** 1.1-5.1
- M** 1.1-4.1
- N** 1.1-1.3
- S** 1.1-1.3
- S** 2.2-2.6

Bestell-Code · Order code

d_1	r_1	r_2	l_2	l_1	l_3	l_4	$\varnothing d_3$	$\varnothing d_2$ h6	Z (Flutes)	Dimens.- Code	3554LZ			
8	1	40	12	80	42	44	7	8	4	.08040A	●			
10	1,5	45	12	95	52	55	8,5	10	4	.10045A	●			
12	2	50	14	100	61	65	10	12	4	.12050A	●			
16	2	60	18	128	76	80	14	16	4	.16060A	●			



Kreissegment-Fräser mit Tropfenform – ER
Circle segment end mills with oval form – ER

N

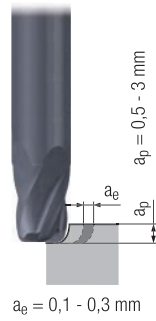

Gültig für · Valid for
3554LZ



	v_c [m/min]	f_z [mm]					
P	1.1	200	$0,005 \times d_1$		■	□	■
	2.1	180	$0,004 \times d_1$		■	□	■
	3.1	160	$0,004 \times d_1$		■	□	■
	4.1	140	$0,003 \times d_1$		■	□	■
	5.1	120	$0,003 \times d_1$		■	□	■
M	1.1	120	$0,005 \times d_1$				■
	2.1	100	$0,004 \times d_1$				■
	3.1	80	$0,003 \times d_1$				■
	4.1	80	$0,003 \times d_1$				■
K	1.1						
	1.2						
	2.1						
	2.2						
	3.1						
	4.1						
N	1.1	400	$0,006 \times d_1$				■
	1.2	280	$0,005 \times d_1$				■
	1.3	200	$0,004 \times d_1$				■
	1.4						
	1.5						
	1.6						
	2.1						
	2.2						
	2.3						
	2.4						
	2.5						
	2.6						
	2.7						
	2.8						
	3.1						
	3.2						
4.1							
4.2							
4.3							
4.4							
5.1							
5.2							
5.3							
S	1.1	120	$0,005 \times d_1$				■
	1.2	100	$0,004 \times d_1$				■
	1.3	60	$0,003 \times d_1$				■
	2.1						
	2.2	30	$0,003 \times d_1$				■
	2.3	30	$0,002 \times d_1$				■
	2.4	30	$0,003 \times d_1$				■
2.5	20	$0,002 \times d_1$				■	
2.6	30	$0,002 \times d_1$				■	
H	1.1						
	1.2						
	1.3						
	1.4						
	1.5						

v_c = Schnittgeschwindigkeit · Cutting speed
 f_z = Vorschub pro Zahn · Feed per tooth

■ = sehr gut geeignet · very suitable
□ = gut geeignet · suitable

- Hochleistungswerkzeug
- Mit 4 Schneiden
- Vibrationsarme Bearbeitung
- Hocheffiziente Schlichtbearbeitung
- Formtoleranz $\pm 0,01$ mm
- High performance tool
- With 4 flutes
- Low-vibration machining
- Highly efficient finishing
- Form tolerance ± 0.01 mm

N

HM

DIN 6535



Form

$\pm 0,01$

30°



Optional



Tonnenform – ER
Barrel Form – ER



Allround

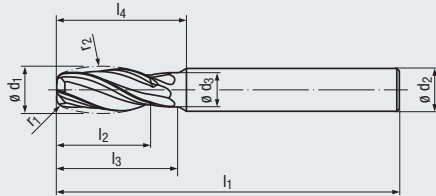
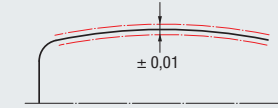

Beschichtung · Coating

Einsatzgebiete – Material (siehe Seite 4)

- Speziell für hochfeste Werkstoffe geeignet
- In fast allen Werkstoffen einsetzbar
- Zum HSC-Schlichten geeignet

Applications – material (see page 4)

- Especially suitable for high-strength materials
- For almost all materials
- Suitable for HSC finishing

ALCR

P	1.1-5.1	
M	1.1-2.1	3.1-4.1
K	1.1-2.1	2.2
K	3.1-4.1	4.2
N	1.1-1.4	
N	2.1-3.2	4.1-4.2, 5.2
S	1.1-2.2	2.3
S	2.4	2.5-2.6
H	1.1-1.2	

Bestell-Code · Order code

3542L

d ₁	r ₁	r ₂	l ₂	l ₃	l ₁	∅ d ₃	l ₄	∅ d ₂ h6	Z (Flutes)	Dimens.- Code
10	2	50	21	28	80	8	30	10	4	.10050A

Baumaße für Werkzeugdatenbank Dimensions for tool database

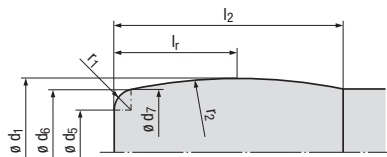

d ₁	r ₁	r ₂	l ₂	l _r	∅ d ₅	∅ d ₆	∅ d ₇
10	2	50	21	11,747	4	7,917	8

- $l_r = r_2$ trifft tangential (theoretisch) auf d_1
 r_2 is (theoretically) tangential to d_1
- $d_6 =$ Tangentialpunkt von r_1 und r_2
Tangent point of r_1 and r_2
- $d_7 = d_5 + 2 \times r_1$

EMUGE-FRANKEN-Werkzeuge sind bereit für Industrie 4.0.

Ab sofort steht der digitale Zwilling zu vielen unserer Katalogwerkzeuge für Sie zum Download auf unserer Homepage bereit.

EMUGE-FRANKEN tools are ready for Industry 4.0.

From now on the digital twin created for a wide variety of our catalogue tools can be downloaded directly from our homepage.

tooldata.ef-apps.de

Hartmetall-Kreissegment-Fräser mit Tonnenform – ER
Solid carbide circle segment end mill with barrel form – ER

N



Aufmaß · Allowance
0,05 - 0,1 mm



Aufmaß · Allowance
0,1 - 0,2 mm

Gültig für · Valid for
3542L

Für die Berechnung der Drehzahl n muss mit dem Durchmesser d₁ gerechnet werden.
In order to calculate the rotational speed n, the diameter d₁ has to be used.



	V _c [m/min]	f _z [mm]	V _c [m/min]	f _z [mm]			MMS MQL		
P	1.1	420	0,004 x d ₁	420	0,003 x d ₁	<input type="checkbox"/>	<input checked="" type="checkbox"/>	<input type="checkbox"/>	<input checked="" type="checkbox"/>
	2.1	375	0,004 x d ₁	375	0,003 x d ₁	<input type="checkbox"/>	<input checked="" type="checkbox"/>	<input type="checkbox"/>	<input checked="" type="checkbox"/>
	3.1	315	0,003 x d ₁	315	0,003 x d ₁	<input type="checkbox"/>	<input checked="" type="checkbox"/>	<input type="checkbox"/>	<input checked="" type="checkbox"/>
	4.1	300	0,003 x d ₁	300	0,002 x d ₁	<input type="checkbox"/>	<input checked="" type="checkbox"/>		
	5.1	270	0,003 x d ₁	270	0,002 x d ₁	<input type="checkbox"/>	<input checked="" type="checkbox"/>		
M	1.1	150	0,005 x d ₁	150	0,003 x d ₁			<input type="checkbox"/>	<input checked="" type="checkbox"/>
	2.1	120	0,005 x d ₁	120	0,003 x d ₁			<input type="checkbox"/>	<input checked="" type="checkbox"/>
	3.1	90	0,004 x d ₁	90	0,002 x d ₁			<input type="checkbox"/>	<input checked="" type="checkbox"/>
	4.1	60	0,004 x d ₁	60	0,002 x d ₁			<input type="checkbox"/>	<input checked="" type="checkbox"/>
K	1.1	280	0,005 x d ₁	280	0,004 x d ₁	<input type="checkbox"/>	<input checked="" type="checkbox"/>		
	1.2	280	0,005 x d ₁	280	0,004 x d ₁	<input type="checkbox"/>	<input checked="" type="checkbox"/>		
	2.1	250	0,004 x d ₁	250	0,003 x d ₁	<input type="checkbox"/>	<input checked="" type="checkbox"/>		
	2.2	250	0,004 x d ₁	250	0,003 x d ₁	<input type="checkbox"/>	<input checked="" type="checkbox"/>		
	3.1	210	0,004 x d ₁	210	0,003 x d ₁	<input type="checkbox"/>	<input checked="" type="checkbox"/>		
	3.2	210	0,004 x d ₁	210	0,003 x d ₁	<input type="checkbox"/>	<input checked="" type="checkbox"/>		
	4.1	180	0,003 x d ₁	180	0,002 x d ₁	<input type="checkbox"/>	<input checked="" type="checkbox"/>		
	4.2	140	0,003 x d ₁	140	0,002 x d ₁	<input type="checkbox"/>	<input checked="" type="checkbox"/>		
N	1.1	600	0,004 x d ₁	600	0,003 x d ₁			<input type="checkbox"/>	<input checked="" type="checkbox"/>
	1.2	600	0,004 x d ₁	600	0,003 x d ₁			<input type="checkbox"/>	<input checked="" type="checkbox"/>
	1.3	600	0,003 x d ₁	600	0,002 x d ₁			<input type="checkbox"/>	<input checked="" type="checkbox"/>
	1.4	410	0,004 x d ₁	410	0,003 x d ₁			<input type="checkbox"/>	<input checked="" type="checkbox"/>
	1.5								
	1.6								
	2.1	270	0,005 x d ₁	270	0,004 x d ₁			<input type="checkbox"/>	<input checked="" type="checkbox"/>
	2.2	270	0,005 x d ₁	270	0,004 x d ₁			<input type="checkbox"/>	<input checked="" type="checkbox"/>
	2.3	270	0,005 x d ₁	270	0,004 x d ₁		<input type="checkbox"/>	<input type="checkbox"/>	<input checked="" type="checkbox"/>
	2.4	255	0,004 x d ₁	255	0,003 x d ₁		<input type="checkbox"/>	<input type="checkbox"/>	<input checked="" type="checkbox"/>
	2.5	255	0,004 x d ₁	255	0,003 x d ₁		<input type="checkbox"/>	<input type="checkbox"/>	<input checked="" type="checkbox"/>
	2.6	255	0,004 x d ₁	255	0,003 x d ₁		<input type="checkbox"/>	<input type="checkbox"/>	<input checked="" type="checkbox"/>
	2.7	150	0,003 x d ₁	150	0,002 x d ₁		<input type="checkbox"/>	<input type="checkbox"/>	<input checked="" type="checkbox"/>
	2.8	150	0,003 x d ₁	150	0,002 x d ₁		<input type="checkbox"/>	<input type="checkbox"/>	<input checked="" type="checkbox"/>
	3.1	410	0,005 x d ₁	410	0,004 x d ₁			<input type="checkbox"/>	<input checked="" type="checkbox"/>
	3.2	410	0,005 x d ₁	410	0,004 x d ₁			<input type="checkbox"/>	<input checked="" type="checkbox"/>
4.1	410	0,005 x d ₁	410	0,004 x d ₁		<input type="checkbox"/>	<input type="checkbox"/>	<input checked="" type="checkbox"/>	
4.2	600	0,005 x d ₁	600	0,004 x d ₁		<input type="checkbox"/>	<input type="checkbox"/>	<input checked="" type="checkbox"/>	
4.3									
4.4									
5.1									
5.2	150	0,005 x d ₁	150	0,003 x d ₁				<input checked="" type="checkbox"/>	
5.3									
S	1.1	100	0,006 x d ₁	100	0,004 x d ₁				<input checked="" type="checkbox"/>
	1.2	80	0,005 x d ₁	80	0,003 x d ₁				<input checked="" type="checkbox"/>
	1.3	60	0,005 x d ₁	60	0,003 x d ₁				<input checked="" type="checkbox"/>
	2.1	80	0,004 x d ₁	80	0,002 x d ₁				<input checked="" type="checkbox"/>
	2.2	30	0,004 x d ₁	30	0,002 x d ₁				<input checked="" type="checkbox"/>
	2.3	30	0,004 x d ₁	30	0,002 x d ₁				<input checked="" type="checkbox"/>
	2.4	30	0,004 x d ₁	30	0,002 x d ₁				<input checked="" type="checkbox"/>
2.5	30	0,004 x d ₁	30	0,002 x d ₁				<input checked="" type="checkbox"/>	
2.6	30	0,004 x d ₁	30	0,002 x d ₁				<input checked="" type="checkbox"/>	
H	1.1	130	0,005 x d ₁	130	0,003 x d ₁	<input type="checkbox"/>	<input checked="" type="checkbox"/>		
	1.2	100	0,005 x d ₁	100	0,003 x d ₁	<input type="checkbox"/>	<input checked="" type="checkbox"/>		
	1.3								
	1.4								
	1.5								

v_c = Schnittgeschwindigkeit · Cutting speed
f_z = Vorschub pro Zahn · Feed per tooth

■ = sehr gut geeignet · very suitable
□ = gut geeignet · suitable

- Hochleistungswerkzeug
- Mit 3 oder 4 Schneiden
- Vibrationsarme Bearbeitung
- Hocheffiziente Schlichtbearbeitung
- Formtoleranz $\pm 0,01$ mm
- High performance tool
- With 3 or 4 flutes
- Low-vibration machining
- Highly efficient finishing
- Form tolerance ± 0.01 mm

N

HM

DIN 6535
HA
HB

Form
 $\pm 0,01$

30°

Optional

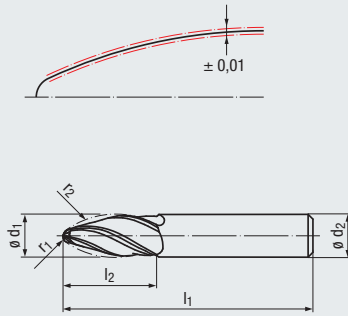

Tropfenform – VR
Oval Form – VR



Allround

Beschichtung · Coating

Einsatzgebiete – Material (siehe Seite 4)

- Speziell für hochfeste Werkstoffe geeignet
- In fast allen Werkstoffen einsetzbar
- Zum HSC-Schlichten geeignet

Applications – material (see page 4)

- Especially suitable for high-strength materials
- For almost all materials
- Suitable for HSC finishing

ALCR

P	1.1-5.1	
M	1.1-2.1	3.1-4.1
K	1.1-2.1	2.2
K	3.1-4.1	4.2
N	1.1-1.4	
N	2.1-3.2	4.1-4.2, 5.2
S	1.1-2.2	2.3
S	2.4	2.5-2.6
H		1.1-1.2

Bestell-Code · Order code

d ₁	r ₁	r ₂	l ₂	l ₁	∅ d ₂ h6	Z (Flutes)	Dimens.- Code	3538L			
6	1	95	22	62	6	3	.06095A	●			
8	1	90	25	68	8	3	.08090A	●			
10	2	85	26	72	10	4	.10085A	●			
12	2	80	28	83	12	4	.12080A	●			
16	3	75	31	92	16	4	.16075A	●			

Bearbeitungsbeispiel

Bauteil: Flansch einer Treibstoffleitung aus der Luftfahrtindustrie

Anwendung: Schlichtbearbeitung der runden Innenkontur sowie Teile der Außenkontur

Machining example

Component: Flange of a fuel pipe from the aviation industry

Application: Finishing of the round inner contour and parts of the outer contour



Hartmetall-Kreissegment-Fräser mit Tropfenform – VR
Solid carbide circle segment end mills with oval form – VR

N

Gültig für · Valid for
3538L



Aufmaß · Allowance
0,05 - 0,1 mm



Aufmaß · Allowance
0,1 - 0,2 mm



Aufmaß · Allowance
0,2 - 0,3 mm

Für die Berechnung der Drehzahl n muss mit dem Durchmesser d_1 gerechnet werden.
In order to calculate the rotational speed n, the diameter d_1 has to be used.



		Aufmaß 0,05 - 0,1 mm		Aufmaß 0,1 - 0,2 mm		Aufmaß 0,2 - 0,3 mm					
		V_c [m/min]	f_z [mm]	V_c [m/min]	f_z [mm]	V_c [m/min]	f_z [mm]				
P	1.1	420	$0,004 \times d_1$	420	$0,003 \times d_1$	420	$0,003 \times d_1$	<input type="checkbox"/>	<input checked="" type="checkbox"/>	<input type="checkbox"/>	<input checked="" type="checkbox"/>
	2.1	375	$0,004 \times d_1$	375	$0,003 \times d_1$	375	$0,003 \times d_1$	<input type="checkbox"/>	<input checked="" type="checkbox"/>	<input type="checkbox"/>	<input checked="" type="checkbox"/>
	3.1	315	$0,003 \times d_1$	315	$0,003 \times d_1$	315	$0,002 \times d_1$	<input type="checkbox"/>	<input checked="" type="checkbox"/>	<input type="checkbox"/>	<input checked="" type="checkbox"/>
	4.1	300	$0,003 \times d_1$	300	$0,002 \times d_1$	300	$0,002 \times d_1$	<input type="checkbox"/>	<input checked="" type="checkbox"/>		
	5.1	270	$0,003 \times d_1$	270	$0,002 \times d_1$	270	$0,002 \times d_1$	<input type="checkbox"/>	<input checked="" type="checkbox"/>		
M	1.1	150	$0,005 \times d_1$	150	$0,004 \times d_1$	150	$0,003 \times d_1$			<input type="checkbox"/>	<input checked="" type="checkbox"/>
	2.1	120	$0,005 \times d_1$	120	$0,004 \times d_1$	120	$0,003 \times d_1$			<input type="checkbox"/>	<input checked="" type="checkbox"/>
	3.1	90	$0,004 \times d_1$	90	$0,003 \times d_1$	90	$0,002 \times d_1$			<input type="checkbox"/>	<input checked="" type="checkbox"/>
	4.1	60	$0,004 \times d_1$	60	$0,003 \times d_1$	60	$0,002 \times d_1$			<input type="checkbox"/>	<input checked="" type="checkbox"/>
K	1.1	280	$0,005 \times d_1$	280	$0,004 \times d_1$	280	$0,003 \times d_1$	<input type="checkbox"/>	<input checked="" type="checkbox"/>		
	1.2	280	$0,005 \times d_1$	280	$0,004 \times d_1$	280	$0,003 \times d_1$	<input type="checkbox"/>	<input checked="" type="checkbox"/>		
	2.1	250	$0,004 \times d_1$	250	$0,003 \times d_1$	250	$0,003 \times d_1$	<input type="checkbox"/>	<input checked="" type="checkbox"/>		
	2.2	250	$0,004 \times d_1$	250	$0,003 \times d_1$	250	$0,003 \times d_1$	<input type="checkbox"/>	<input checked="" type="checkbox"/>		
	3.1	210	$0,004 \times d_1$	210	$0,003 \times d_1$	210	$0,003 \times d_1$	<input type="checkbox"/>	<input checked="" type="checkbox"/>		
	3.2	210	$0,004 \times d_1$	210	$0,003 \times d_1$	210	$0,003 \times d_1$	<input type="checkbox"/>	<input checked="" type="checkbox"/>		
	4.1	180	$0,003 \times d_1$	180	$0,002 \times d_1$	180	$0,002 \times d_1$	<input type="checkbox"/>	<input checked="" type="checkbox"/>		
	4.2	140	$0,003 \times d_1$	140	$0,002 \times d_1$	140	$0,002 \times d_1$	<input type="checkbox"/>	<input checked="" type="checkbox"/>		
N	1.1	600	$0,004 \times d_1$	600	$0,003 \times d_1$	600	$0,003 \times d_1$			<input type="checkbox"/>	<input checked="" type="checkbox"/>
	1.2	600	$0,004 \times d_1$	600	$0,003 \times d_1$	600	$0,003 \times d_1$			<input type="checkbox"/>	<input checked="" type="checkbox"/>
	1.3	600	$0,003 \times d_1$	600	$0,002 \times d_1$	600	$0,002 \times d_1$			<input type="checkbox"/>	<input checked="" type="checkbox"/>
	1.4	410	$0,004 \times d_1$	410	$0,003 \times d_1$	410	$0,003 \times d_1$			<input type="checkbox"/>	<input checked="" type="checkbox"/>
	1.5										
	1.6										
	2.1	270	$0,005 \times d_1$	270	$0,004 \times d_1$	270	$0,003 \times d_1$			<input type="checkbox"/>	<input checked="" type="checkbox"/>
	2.2	270	$0,005 \times d_1$	270	$0,004 \times d_1$	270	$0,003 \times d_1$			<input type="checkbox"/>	<input checked="" type="checkbox"/>
	2.3	270	$0,005 \times d_1$	270	$0,004 \times d_1$	270	$0,003 \times d_1$			<input type="checkbox"/>	<input checked="" type="checkbox"/>
	2.4	255	$0,004 \times d_1$	255	$0,003 \times d_1$	255	$0,003 \times d_1$	<input type="checkbox"/>	<input type="checkbox"/>	<input type="checkbox"/>	<input checked="" type="checkbox"/>
	2.5	255	$0,004 \times d_1$	255	$0,003 \times d_1$	255	$0,003 \times d_1$			<input type="checkbox"/>	<input checked="" type="checkbox"/>
	2.6	255	$0,004 \times d_1$	255	$0,003 \times d_1$	255	$0,003 \times d_1$			<input type="checkbox"/>	<input checked="" type="checkbox"/>
	2.7	150	$0,003 \times d_1$	150	$0,002 \times d_1$	150	$0,002 \times d_1$	<input type="checkbox"/>	<input type="checkbox"/>	<input type="checkbox"/>	<input checked="" type="checkbox"/>
	2.8	150	$0,003 \times d_1$	150	$0,002 \times d_1$	150	$0,002 \times d_1$			<input type="checkbox"/>	<input checked="" type="checkbox"/>
	3.1	410	$0,005 \times d_1$	410	$0,004 \times d_1$	410	$0,003 \times d_1$			<input type="checkbox"/>	<input checked="" type="checkbox"/>
	3.2	410	$0,005 \times d_1$	410	$0,004 \times d_1$	410	$0,003 \times d_1$			<input type="checkbox"/>	<input checked="" type="checkbox"/>
4.1	410	$0,005 \times d_1$	410	$0,004 \times d_1$	410	$0,003 \times d_1$			<input type="checkbox"/>	<input checked="" type="checkbox"/>	
4.2	600	$0,005 \times d_1$	600	$0,004 \times d_1$	600	$0,003 \times d_1$			<input type="checkbox"/>	<input checked="" type="checkbox"/>	
4.3											
4.4											
5.1											
5.2	150	$0,005 \times d_1$	150	$0,004 \times d_1$	150	$0,003 \times d_1$				<input checked="" type="checkbox"/>	
5.3											
S	1.1	100	$0,006 \times d_1$	100	$0,005 \times d_1$	100	$0,004 \times d_1$				<input checked="" type="checkbox"/>
	1.2	80	$0,005 \times d_1$	80	$0,004 \times d_1$	80	$0,003 \times d_1$				<input checked="" type="checkbox"/>
	1.3	60	$0,005 \times d_1$	60	$0,004 \times d_1$	60	$0,003 \times d_1$				<input checked="" type="checkbox"/>
	2.1	80	$0,004 \times d_1$	80	$0,003 \times d_1$	80	$0,002 \times d_1$				<input checked="" type="checkbox"/>
	2.2	30	$0,004 \times d_1$	30	$0,003 \times d_1$	30	$0,002 \times d_1$				<input checked="" type="checkbox"/>
	2.3	30	$0,004 \times d_1$	30	$0,003 \times d_1$	30	$0,002 \times d_1$				<input checked="" type="checkbox"/>
	2.4	30	$0,004 \times d_1$	30	$0,003 \times d_1$	30	$0,002 \times d_1$				<input checked="" type="checkbox"/>
	2.5	30	$0,004 \times d_1$	30	$0,003 \times d_1$	30	$0,002 \times d_1$				<input checked="" type="checkbox"/>
2.6	30	$0,004 \times d_1$	30	$0,003 \times d_1$	30	$0,002 \times d_1$				<input checked="" type="checkbox"/>	
H	1.1	130	$0,005 \times d_1$	130	$0,004 \times d_1$	130	$0,003 \times d_1$	<input type="checkbox"/>	<input checked="" type="checkbox"/>		
	1.2	100	$0,005 \times d_1$	100	$0,004 \times d_1$	100	$0,003 \times d_1$	<input type="checkbox"/>	<input checked="" type="checkbox"/>		
	1.3										
	1.4										
	1.5										

v_c = Schnittgeschwindigkeit · Cutting speed
 f_z = Vorschub pro Zahn · Feed per tooth

■ = sehr gut geeignet · very suitable
□ = gut geeignet · suitable

- Hochleistungswerkzeug
- Mit 6 Schneiden
- Vibrationsarme Bearbeitung
- Hocheffiziente Schlichtbearbeitung
- Formtoleranz $\pm 0,01$ mm
- High performance tool
- With 6 flutes
- Low-vibration machining
- Highly efficient finishing
- Form tolerance ± 0.01 mm

N

HM

DIN 6535
HA
HB

Form
 $\pm 0,01$

30°

Optional

≤ 60
HRC

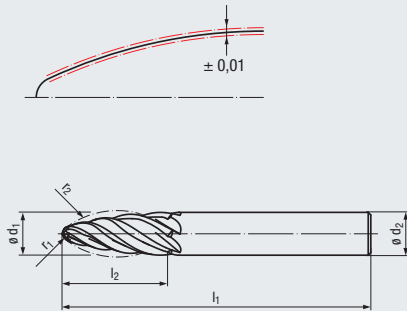

Tropfenform – VR Oval Form – VR



Allround

Beschichtung · Coating

Einsatzgebiete – Material (siehe Seite 4)

- Speziell für hochfeste Werkstoffe geeignet
- In fast allen Werkstoffen einsetzbar
- Hartbearbeitung bis 60 HRC möglich
- Zum HSC-Schlichten geeignet

Applications – material (see page 4)

- Especially suitable for high-strength materials
- For almost all materials
- Hard machining of up to 60 HRC
- Suitable for HSC finishing

ALCR

P	1.1-5.1	
M	1.1-2.1	3.1-4.1
K	1.1-2.1	2.2
K	3.1-4.1	4.2
N	1.1-1.4	
N	2.1-3.2	4.1-4.2, 5.2
S	1.1-2.2	2.3
S	2.4	2.5-2.6
H	1.1-1.3	

Bestell-Code · Order code

d ₁	r ₁	r ₂	l ₂	l ₁	∅ d ₂ h6	Z (Flutes)	Dimens.- Code	3539L			
10	2	85	26	72	10	6	.10085A	●			
12	2	80	28	83	12	6	.12080A	●			
16	3	75	31	92	16	6	.16075A	●			

Bearbeitungsbeispiel

Bauteil: Lagerbock aus dem Maschinenbau

Anwendung: Komplette Schlichtbearbeitung der Außenkontur, Innenkontur und der Taschen

Machining example

Component: Bearing block from mechanical engineering

Application: Complete finishing of the the outer contour, inner contour and the pockets

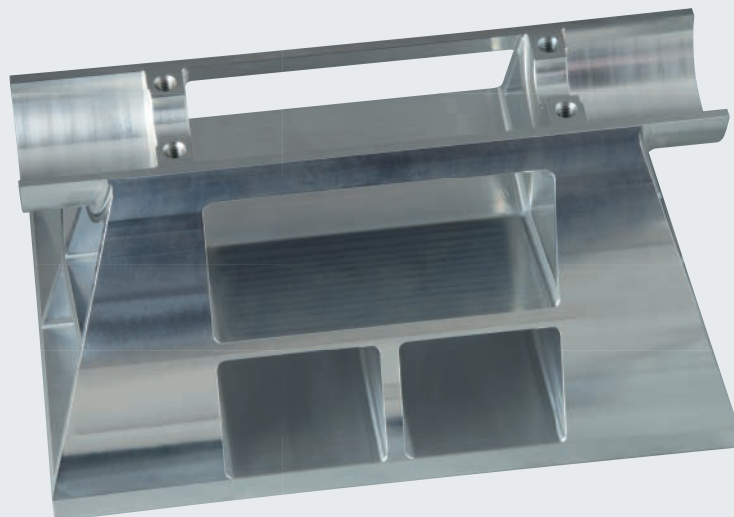

Hartmetall-Kreissegment-Fräser mit Tropfenform – VR
Solid carbide circle segment end mills with oval form – VR

N



Aufmaß · Allowance
0,05 - 0,1 mm



Aufmaß · Allowance
0,1 - 0,2 mm

Gültig für · Valid for
3539L

Für die Berechnung der Drehzahl n muss mit dem Durchmesser d_1 gerechnet werden.

In order to calculate the rotational speed n, the diameter d_1 has to be used.



	V_c [m/min]	f_z [mm]	V_c [m/min]	f_z [mm]			MMS MQL	
P	1.1	$0,003 \times d_1$	420	$0,002 \times d_1$	<input type="checkbox"/>	<input checked="" type="checkbox"/>	<input type="checkbox"/>	<input checked="" type="checkbox"/>
	2.1	$0,003 \times d_1$	375	$0,002 \times d_1$	<input type="checkbox"/>	<input checked="" type="checkbox"/>	<input type="checkbox"/>	<input checked="" type="checkbox"/>
	3.1	$0,002 \times d_1$	315	$0,002 \times d_1$	<input type="checkbox"/>	<input checked="" type="checkbox"/>	<input type="checkbox"/>	<input checked="" type="checkbox"/>
	4.1	$0,002 \times d_1$	300	$0,001 \times d_1$	<input type="checkbox"/>	<input checked="" type="checkbox"/>	<input type="checkbox"/>	<input type="checkbox"/>
	5.1	$0,002 \times d_1$	270	$0,001 \times d_1$	<input type="checkbox"/>	<input checked="" type="checkbox"/>	<input type="checkbox"/>	<input type="checkbox"/>
M	1.1	$0,003 \times d_1$	150	$0,002 \times d_1$			<input type="checkbox"/>	<input checked="" type="checkbox"/>
	2.1	$0,003 \times d_1$	120	$0,002 \times d_1$			<input type="checkbox"/>	<input checked="" type="checkbox"/>
	3.1	$0,002 \times d_1$	90	$0,001 \times d_1$			<input type="checkbox"/>	<input checked="" type="checkbox"/>
	4.1	$0,002 \times d_1$	60	$0,001 \times d_1$			<input type="checkbox"/>	<input checked="" type="checkbox"/>
K	1.1	$0,004 \times d_1$	280	$0,003 \times d_1$	<input type="checkbox"/>	<input checked="" type="checkbox"/>		
	1.2	$0,004 \times d_1$	280	$0,003 \times d_1$	<input type="checkbox"/>	<input checked="" type="checkbox"/>		
	2.1	$0,003 \times d_1$	250	$0,002 \times d_1$	<input type="checkbox"/>	<input checked="" type="checkbox"/>		
	2.2	$0,003 \times d_1$	250	$0,002 \times d_1$	<input type="checkbox"/>	<input checked="" type="checkbox"/>		
	3.1	$0,003 \times d_1$	210	$0,002 \times d_1$	<input type="checkbox"/>	<input checked="" type="checkbox"/>		
	3.2	$0,003 \times d_1$	210	$0,002 \times d_1$	<input type="checkbox"/>	<input checked="" type="checkbox"/>		
	4.1	$0,002 \times d_1$	180	$0,001 \times d_1$	<input type="checkbox"/>	<input checked="" type="checkbox"/>		
	4.2	$0,002 \times d_1$	140	$0,001 \times d_1$	<input type="checkbox"/>	<input checked="" type="checkbox"/>		
N	1.1	$0,003 \times d_1$	600	$0,002 \times d_1$			<input type="checkbox"/>	<input checked="" type="checkbox"/>
	1.2	$0,003 \times d_1$	600	$0,002 \times d_1$			<input type="checkbox"/>	<input checked="" type="checkbox"/>
	1.3	$0,002 \times d_1$	600	$0,001 \times d_1$			<input type="checkbox"/>	<input checked="" type="checkbox"/>
	1.4	$0,003 \times d_1$	410	$0,002 \times d_1$			<input type="checkbox"/>	<input checked="" type="checkbox"/>
	1.5							
	1.6							
	2.1	$0,004 \times d_1$	270	$0,003 \times d_1$			<input type="checkbox"/>	<input checked="" type="checkbox"/>
	2.2	$0,004 \times d_1$	270	$0,003 \times d_1$			<input type="checkbox"/>	<input checked="" type="checkbox"/>
	2.3	$0,004 \times d_1$	270	$0,003 \times d_1$		<input type="checkbox"/>	<input type="checkbox"/>	<input checked="" type="checkbox"/>
	2.4	$0,003 \times d_1$	255	$0,002 \times d_1$		<input type="checkbox"/>	<input type="checkbox"/>	<input checked="" type="checkbox"/>
	2.5	$0,003 \times d_1$	255	$0,002 \times d_1$		<input type="checkbox"/>	<input type="checkbox"/>	<input checked="" type="checkbox"/>
	2.6	$0,003 \times d_1$	255	$0,002 \times d_1$		<input type="checkbox"/>	<input type="checkbox"/>	<input checked="" type="checkbox"/>
	2.7	$0,002 \times d_1$	150	$0,001 \times d_1$		<input type="checkbox"/>	<input type="checkbox"/>	<input checked="" type="checkbox"/>
	2.8	$0,002 \times d_1$	150	$0,001 \times d_1$		<input type="checkbox"/>	<input type="checkbox"/>	<input checked="" type="checkbox"/>
	3.1	$0,004 \times d_1$	410	$0,003 \times d_1$			<input type="checkbox"/>	<input checked="" type="checkbox"/>
	3.2	$0,004 \times d_1$	410	$0,003 \times d_1$			<input type="checkbox"/>	<input checked="" type="checkbox"/>
4.1	$0,004 \times d_1$	410	$0,003 \times d_1$		<input type="checkbox"/>	<input type="checkbox"/>	<input checked="" type="checkbox"/>	
4.2	$0,004 \times d_1$	600	$0,003 \times d_1$		<input type="checkbox"/>	<input type="checkbox"/>	<input checked="" type="checkbox"/>	
4.3								
4.4								
5.1								
5.2	$0,003 \times d_1$	150	$0,002 \times d_1$				<input checked="" type="checkbox"/>	
5.3								
S	1.1	$0,005 \times d_1$	100	$0,004 \times d_1$				<input checked="" type="checkbox"/>
	1.2	$0,004 \times d_1$	80	$0,003 \times d_1$				<input checked="" type="checkbox"/>
	1.3	$0,004 \times d_1$	60	$0,003 \times d_1$				<input checked="" type="checkbox"/>
	2.1	$0,003 \times d_1$	80	$0,002 \times d_1$				<input checked="" type="checkbox"/>
	2.2	$0,003 \times d_1$	30	$0,002 \times d_1$				<input checked="" type="checkbox"/>
	2.3	$0,003 \times d_1$	30	$0,002 \times d_1$				<input checked="" type="checkbox"/>
	2.4	$0,003 \times d_1$	30	$0,002 \times d_1$				<input checked="" type="checkbox"/>
2.5	$0,003 \times d_1$	30	$0,002 \times d_1$				<input checked="" type="checkbox"/>	
2.6	$0,003 \times d_1$	30	$0,002 \times d_1$				<input checked="" type="checkbox"/>	
H	1.1	$0,004 \times d_1$	130	$0,003 \times d_1$	<input type="checkbox"/>	<input checked="" type="checkbox"/>		
	1.2	$0,004 \times d_1$	100	$0,003 \times d_1$	<input type="checkbox"/>	<input checked="" type="checkbox"/>		
	1.3	$0,003 \times d_1$	80	$0,002 \times d_1$	<input type="checkbox"/>	<input checked="" type="checkbox"/>		
	1.4							
	1.5							

v_c = Schnittgeschwindigkeit · Cutting speed
 f_z = Vorschub pro Zahn · Feed per tooth

= sehr gut geeignet · very suitable
 = gut geeignet · suitable

- Hochleistungswerkzeug
- Mit 2 oder 3 Schneiden
- Vibrationsarme Bearbeitung
- Hocheffiziente Schlichtbearbeitung
- Formtoleranz $\pm 0,01$ mm
- High performance tool
- With 2 or 3 flutes
- Low-vibration machining
- Highly efficient finishing
- Form tolerance ± 0.01 mm

N

HM

DIN 6535 Form $\pm 0,01$

HA HB

20-30°

Optional

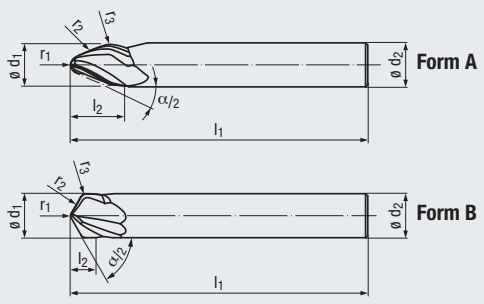
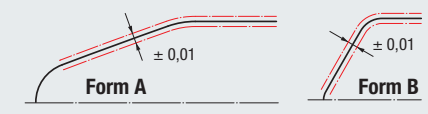

Kegelform – VR Taper Form – VR

Form A
<math>< 45^\circ</math>

Form B
> 45°

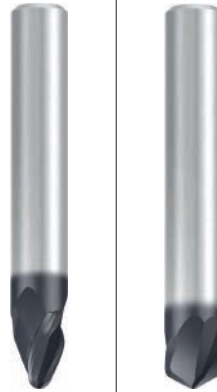

Allround

Beschichtung · Coating

Einsatzgebiete – Material (siehe Seite 4)

- Speziell für hochfeste Werkstoffe geeignet
- In fast allen Werkstoffen einsetzbar
- Zum HSC-Schlichten geeignet
- Form A: bis 45° Anstellwinkel für steile Bereiche
- Form B: über 45° Anstellwinkel für flache Bereiche

Applications – material (see page 4)

- Especially suitable for high-strength materials
- For almost all materials
- Suitable for HSC finishing
- Form A: up to 45° tilt angle for steep areas
- Form B: more than 45° tilt angle for flat areas

ALCR

P	1.1-5.1	
M	1.1-2.1	3.1-4.1
K	1.1-2.1	2.2
K	3.1-4.1	4.2
N	1.1-1.4	
N	2.1-3.2	4.1-4.2, 5.2
S	1.1-2.2	2.3
S	2.4	2.5-2.6
H		1.1-1.2

Bestell-Code · Order code

$\alpha/2$	θd_1	r_1	r_2	r_3	l_2	l_1	θd_2 h6	Z (Flutes)	Dimens.- Code	3540L		
12,5°	16	2	1000	5	31	108	16	3	.1610AA	●		
12,5°	16	4	1000	5	24	108	16	3	.1610AB	●		
17,5°	6	1	250	3	9,5	62	6	3	.06250A	●		
20°	8	1,5	250	4	10,5	68	8	3	.08250A	●		
20°	10	2	250	5	12,5	80	10	3	.10250A	●		
20°	12	3	250	6	13,5	93	12	3	.12250A	●		
20°	16	4	500	8	18,5	108	16	3	.16500A	●		
20°	16	4	1500	8	18,5	108	16	3	.1615AA	●		
42,5°	12	1	200	1	8	93	12	3	.12200A	●		
60°	10	1	200	1,5	6	80	10	2	.10200A		●	
70°	10	1	200	2	6	80	10	2	.10200B		●	



Hartmetall-Kreissegment-Fräser mit Kegelform – VR
Solid carbide circle segment end mills with taper form – VR

N

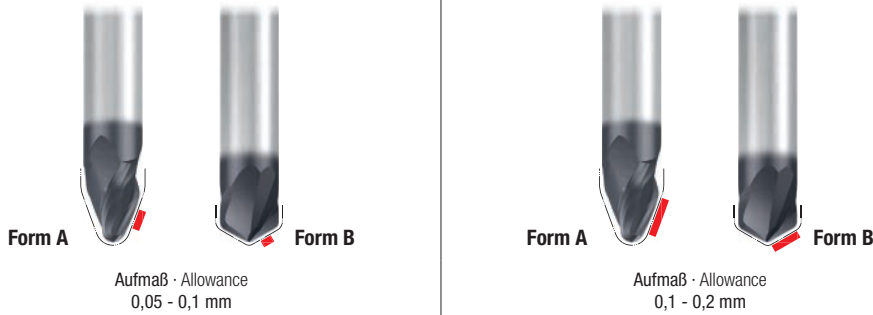

Gültig für · Valid for
3540L

Für die Berechnung der Drehzahl n muss mit dem Durchmesser d_1 gerechnet werden.
In order to calculate the rotational speed n, the diameter d_1 has to be used.



		Aufmaß - Allowance 0,05 - 0,1 mm		Aufmaß - Allowance 0,1 - 0,2 mm					
		V_c [m/min]	f_z [mm]	V_c [m/min]	f_z [mm]				
P	1.1	420	$0,004 \times d_1$	420	$0,003 \times d_1$	<input type="checkbox"/>	<input checked="" type="checkbox"/>	<input type="checkbox"/>	<input checked="" type="checkbox"/>
	2.1	375	$0,004 \times d_1$	375	$0,003 \times d_1$	<input type="checkbox"/>	<input checked="" type="checkbox"/>	<input type="checkbox"/>	<input checked="" type="checkbox"/>
	3.1	315	$0,003 \times d_1$	315	$0,003 \times d_1$	<input type="checkbox"/>	<input checked="" type="checkbox"/>	<input type="checkbox"/>	<input checked="" type="checkbox"/>
	4.1	300	$0,003 \times d_1$	300	$0,002 \times d_1$	<input type="checkbox"/>	<input checked="" type="checkbox"/>		
	5.1	270	$0,003 \times d_1$	270	$0,002 \times d_1$	<input type="checkbox"/>	<input checked="" type="checkbox"/>		
M	1.1	150	$0,004 \times d_1$	150	$0,003 \times d_1$			<input type="checkbox"/>	<input checked="" type="checkbox"/>
	2.1	120	$0,004 \times d_1$	120	$0,003 \times d_1$			<input type="checkbox"/>	<input checked="" type="checkbox"/>
	3.1	90	$0,003 \times d_1$	90	$0,002 \times d_1$			<input type="checkbox"/>	<input checked="" type="checkbox"/>
	4.1	60	$0,003 \times d_1$	60	$0,002 \times d_1$			<input type="checkbox"/>	<input checked="" type="checkbox"/>
K	1.1	280	$0,007 \times d_1$	280	$0,004 \times d_1$	<input type="checkbox"/>	<input checked="" type="checkbox"/>		
	1.2	280	$0,007 \times d_1$	280	$0,004 \times d_1$	<input type="checkbox"/>	<input checked="" type="checkbox"/>		
	2.1	250	$0,006 \times d_1$	250	$0,003 \times d_1$	<input type="checkbox"/>	<input checked="" type="checkbox"/>		
	2.2	250	$0,006 \times d_1$	250	$0,003 \times d_1$	<input type="checkbox"/>	<input checked="" type="checkbox"/>		
	3.1	210	$0,006 \times d_1$	210	$0,003 \times d_1$	<input type="checkbox"/>	<input checked="" type="checkbox"/>		
	3.2	210	$0,006 \times d_1$	210	$0,003 \times d_1$	<input type="checkbox"/>	<input checked="" type="checkbox"/>		
	4.1	180	$0,004 \times d_1$	180	$0,002 \times d_1$	<input type="checkbox"/>	<input checked="" type="checkbox"/>		
	4.2	140	$0,003 \times d_1$	140	$0,002 \times d_1$	<input type="checkbox"/>	<input checked="" type="checkbox"/>		
N	1.1	600	$0,004 \times d_1$	600	$0,003 \times d_1$			<input type="checkbox"/>	<input checked="" type="checkbox"/>
	1.2	600	$0,004 \times d_1$	600	$0,003 \times d_1$			<input type="checkbox"/>	<input checked="" type="checkbox"/>
	1.3	600	$0,003 \times d_1$	600	$0,002 \times d_1$			<input type="checkbox"/>	<input checked="" type="checkbox"/>
	1.4	410	$0,004 \times d_1$	410	$0,003 \times d_1$			<input type="checkbox"/>	<input checked="" type="checkbox"/>
	1.5								
	1.6								
	2.1	270	$0,005 \times d_1$	270	$0,004 \times d_1$			<input type="checkbox"/>	<input checked="" type="checkbox"/>
	2.2	270	$0,005 \times d_1$	270	$0,004 \times d_1$			<input type="checkbox"/>	<input checked="" type="checkbox"/>
	2.3	270	$0,005 \times d_1$	270	$0,004 \times d_1$		<input type="checkbox"/>	<input type="checkbox"/>	<input checked="" type="checkbox"/>
	2.4	255	$0,004 \times d_1$	255	$0,003 \times d_1$		<input type="checkbox"/>	<input type="checkbox"/>	<input checked="" type="checkbox"/>
	2.5	255	$0,004 \times d_1$	255	$0,003 \times d_1$		<input type="checkbox"/>	<input type="checkbox"/>	<input checked="" type="checkbox"/>
	2.6	255	$0,004 \times d_1$	255	$0,003 \times d_1$		<input type="checkbox"/>	<input type="checkbox"/>	<input checked="" type="checkbox"/>
	2.7	150	$0,003 \times d_1$	150	$0,002 \times d_1$		<input type="checkbox"/>	<input type="checkbox"/>	<input checked="" type="checkbox"/>
	2.8	150	$0,003 \times d_1$	150	$0,002 \times d_1$		<input type="checkbox"/>	<input type="checkbox"/>	<input checked="" type="checkbox"/>
	3.1	410	$0,005 \times d_1$	410	$0,004 \times d_1$			<input type="checkbox"/>	<input checked="" type="checkbox"/>
	3.2	410	$0,005 \times d_1$	410	$0,004 \times d_1$			<input type="checkbox"/>	<input checked="" type="checkbox"/>
4.1	410	$0,005 \times d_1$	410	$0,004 \times d_1$		<input type="checkbox"/>	<input type="checkbox"/>	<input checked="" type="checkbox"/>	
4.2	600	$0,005 \times d_1$	600	$0,004 \times d_1$		<input type="checkbox"/>	<input type="checkbox"/>	<input checked="" type="checkbox"/>	
4.3									
4.4									
5.1									
5.2	150	$0,004 \times d_1$	150	$0,003 \times d_1$				<input checked="" type="checkbox"/>	
5.3									
S	1.1	100	$0,005 \times d_1$	100	$0,004 \times d_1$				<input checked="" type="checkbox"/>
	1.2	80	$0,004 \times d_1$	80	$0,003 \times d_1$				<input checked="" type="checkbox"/>
	1.3	60	$0,004 \times d_1$	60	$0,003 \times d_1$				<input checked="" type="checkbox"/>
	2.1	80	$0,003 \times d_1$	80	$0,002 \times d_1$				<input checked="" type="checkbox"/>
	2.2	30	$0,003 \times d_1$	30	$0,002 \times d_1$				<input checked="" type="checkbox"/>
	2.3	30	$0,003 \times d_1$	30	$0,002 \times d_1$				<input checked="" type="checkbox"/>
	2.4	30	$0,003 \times d_1$	30	$0,002 \times d_1$				<input checked="" type="checkbox"/>
	2.5	30	$0,003 \times d_1$	30	$0,002 \times d_1$				<input checked="" type="checkbox"/>
2.6	30	$0,003 \times d_1$	30	$0,002 \times d_1$				<input checked="" type="checkbox"/>	
H	1.1	130	$0,005 \times d_1$	130	$0,003 \times d_1$	<input type="checkbox"/>	<input checked="" type="checkbox"/>		
	1.2	100	$0,005 \times d_1$	100	$0,003 \times d_1$	<input type="checkbox"/>	<input checked="" type="checkbox"/>		
	1.3								
	1.4								
	1.5								

v_c = Schnittgeschwindigkeit · Cutting speed
 f_z = Vorschub pro Zahn · Feed per tooth

= sehr gut geeignet · very suitable
 = gut geeignet · suitable

- Hochleistungswerkzeug
- Mit 4 oder 6 Schneiden
- Vibrationsarme Bearbeitung
- Hocheffiziente Schlichtbearbeitung
- Formtoleranz $\pm 0,01$ mm
- High performance tool
- With 4 or 6 flutes
- Low-vibration machining
- Highly efficient finishing
- Form tolerance ± 0.01 mm

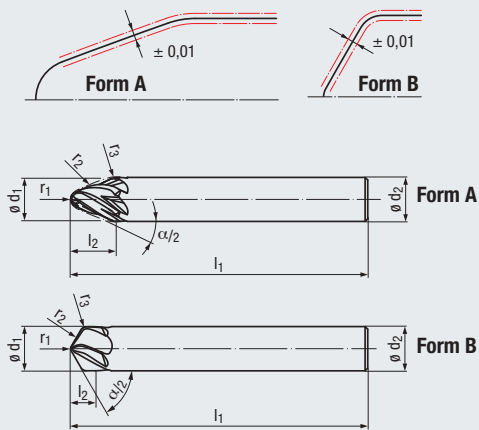

N

HM

DIN 6535 Form $\pm 0,01$

HA HB

20-30°

Optional

≤ 60 HRC

Kegelform – VR Taper Form – VR

Form A
<math>< 45^\circ</math>

Form B
> 45°



Allround

Beschichtung · Coating

Einsatzgebiete – Material (siehe Seite 4)

- Speziell für hochfeste Werkstoffe geeignet
- In fast allen Werkstoffen einsetzbar
- Hartbearbeitung bis 60 HRC möglich
- Zum HSC-Schlichten geeignet
- Form A: bis 45° Anstellwinkel für steile Bereiche
- Form B: über 45° Anstellwinkel für flache Bereiche

Applications – material (see page 4)

- Especially suitable for high-strength materials
- For almost all materials
- Hard machining of up to 60 HRC
- Suitable for HSC finishing
- Form A: up to 45° tilt angle for steep areas
- Form B: more than 45° tilt angle for flat areas

ALCR

P	1.1-5.1	
M	1.1-2.1	3.1-4.1
K	1.1-2.1	2.2
K	3.1-4.1	4.2
N	1.1-1.4	
N	2.1-3.2	4.1-4.2, 5.2
S	1.1-2.2	2.3
S	2.4	2.5-2.6
H	1.1-1.3	

Bestell-Code · Order code

$\alpha/2$	θd_1	r_1	r_2	r_3	l_2	l_1	θd_2 h6	Z (Flutes)	Dimens.- Code	3541L		
12,5°	16	2	1000	5	31	108	16	6	.1610AA	●		
12,5°	16	4	1000	5	24	108	16	6	.1610AB	●		
20°	10	2	250	5	12,5	80	10	6	.10250A	●		
20°	12	3	250	6	13,5	93	12	6	.12250A	●		
20°	16	4	500	8	18,5	108	16	6	.16500A	●		
20°	16	4	1500	8	18,5	108	16	6	.1615AA	●		
42,5°	12	1	200	1	8	93	12	6	.12200A	●		
60°	10	1	200	1,5	6	80	10	4	.10200A		●	
70°	10	1	200	2	6	80	10	4	.10200B		●	

Nur mit Anstellwinkel $\alpha/2$ einsetzen!

Only use with tilt angle $\alpha/2$!

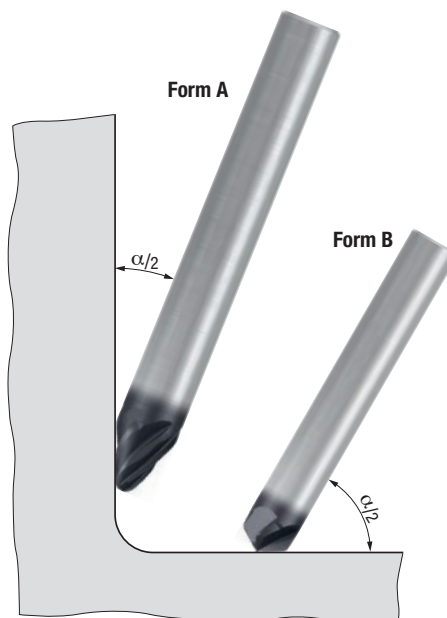

Hartmetall-Kreissegment-Fräser mit Kegelform – VR
Solid carbide circle segment end mills with taper form – VR

N

Gültig für · Valid for
3541L

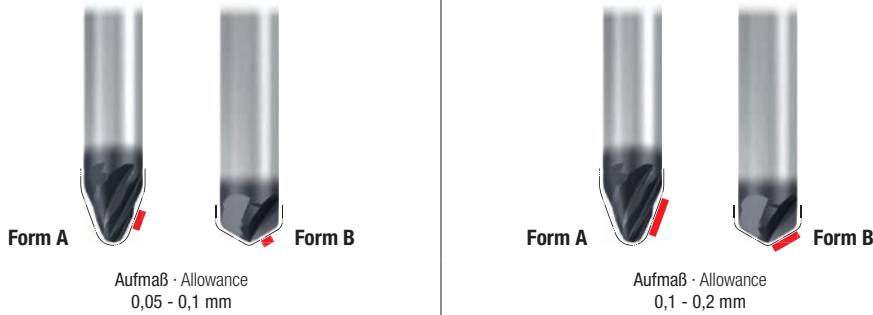

Für die Berechnung der Drehzahl n muss mit dem Durchmesser d₁ gerechnet werden.
In order to calculate the rotational speed n, the diameter d₁ has to be used.



	V _c [m/min]	f _z [mm]	V _c [m/min]	f _z [mm]			
P	1.1	420	0,003 x d ₁	420	0,002 x d ₁	<input type="checkbox"/>	<input checked="" type="checkbox"/>
	2.1	375	0,003 x d ₁	375	0,002 x d ₁	<input type="checkbox"/>	<input checked="" type="checkbox"/>
	3.1	315	0,002 x d ₁	315	0,002 x d ₁	<input type="checkbox"/>	<input checked="" type="checkbox"/>
	4.1	300	0,002 x d ₁	300	0,001 x d ₁	<input type="checkbox"/>	<input checked="" type="checkbox"/>
	5.1	270	0,002 x d ₁	270	0,001 x d ₁	<input type="checkbox"/>	<input checked="" type="checkbox"/>
M	1.1	150	0,003 x d ₁	150	0,002 x d ₁	<input type="checkbox"/>	<input checked="" type="checkbox"/>
	2.1	120	0,003 x d ₁	120	0,002 x d ₁	<input type="checkbox"/>	<input checked="" type="checkbox"/>
	3.1	90	0,002 x d ₁	90	0,001 x d ₁	<input type="checkbox"/>	<input checked="" type="checkbox"/>
	4.1	60	0,002 x d ₁	60	0,001 x d ₁	<input type="checkbox"/>	<input checked="" type="checkbox"/>
K	1.1	280	0,004 x d ₁	280	0,003 x d ₁	<input type="checkbox"/>	<input checked="" type="checkbox"/>
	1.2	280	0,004 x d ₁	280	0,003 x d ₁	<input type="checkbox"/>	<input checked="" type="checkbox"/>
	2.1	250	0,003 x d ₁	250	0,002 x d ₁	<input type="checkbox"/>	<input checked="" type="checkbox"/>
	2.2	250	0,003 x d ₁	250	0,002 x d ₁	<input type="checkbox"/>	<input checked="" type="checkbox"/>
	3.1	210	0,003 x d ₁	210	0,002 x d ₁	<input type="checkbox"/>	<input checked="" type="checkbox"/>
	3.2	210	0,003 x d ₁	210	0,002 x d ₁	<input type="checkbox"/>	<input checked="" type="checkbox"/>
	4.1	180	0,002 x d ₁	180	0,001 x d ₁	<input type="checkbox"/>	<input checked="" type="checkbox"/>
	4.2	140	0,002 x d ₁	140	0,001 x d ₁	<input type="checkbox"/>	<input checked="" type="checkbox"/>
N	1.1	600	0,003 x d ₁	600	0,002 x d ₁	<input type="checkbox"/>	<input checked="" type="checkbox"/>
	1.2	600	0,003 x d ₁	600	0,002 x d ₁	<input type="checkbox"/>	<input checked="" type="checkbox"/>
	1.3	600	0,002 x d ₁	600	0,001 x d ₁	<input type="checkbox"/>	<input checked="" type="checkbox"/>
	1.4	410	0,003 x d ₁	410	0,002 x d ₁	<input type="checkbox"/>	<input checked="" type="checkbox"/>
	1.5						
	1.6						
	2.1	270	0,004 x d ₁	270	0,003 x d ₁	<input type="checkbox"/>	<input checked="" type="checkbox"/>
	2.2	270	0,004 x d ₁	270	0,003 x d ₁	<input type="checkbox"/>	<input checked="" type="checkbox"/>
	2.3	270	0,004 x d ₁	270	0,003 x d ₁	<input type="checkbox"/>	<input checked="" type="checkbox"/>
	2.4	255	0,003 x d ₁	255	0,002 x d ₁	<input type="checkbox"/>	<input checked="" type="checkbox"/>
	2.5	255	0,003 x d ₁	255	0,002 x d ₁	<input type="checkbox"/>	<input checked="" type="checkbox"/>
	2.6	255	0,003 x d ₁	255	0,002 x d ₁	<input type="checkbox"/>	<input checked="" type="checkbox"/>
	2.7	150	0,002 x d ₁	150	0,001 x d ₁	<input type="checkbox"/>	<input checked="" type="checkbox"/>
	2.8	150	0,002 x d ₁	150	0,001 x d ₁	<input type="checkbox"/>	<input checked="" type="checkbox"/>
	3.1	410	0,004 x d ₁	410	0,003 x d ₁	<input type="checkbox"/>	<input checked="" type="checkbox"/>
	3.2	410	0,004 x d ₁	410	0,003 x d ₁	<input type="checkbox"/>	<input checked="" type="checkbox"/>
4.1	410	0,004 x d ₁	410	0,003 x d ₁	<input type="checkbox"/>	<input checked="" type="checkbox"/>	
4.2	600	0,004 x d ₁	600	0,003 x d ₁	<input type="checkbox"/>	<input checked="" type="checkbox"/>	
4.3							
4.4							
5.1							
5.2	150	0,003 x d ₁	150	0,002 x d ₁		<input checked="" type="checkbox"/>	
5.3							
S	1.1	100	0,005 x d ₁	100	0,004 x d ₁		<input checked="" type="checkbox"/>
	1.2	80	0,004 x d ₁	80	0,003 x d ₁		<input checked="" type="checkbox"/>
	1.3	60	0,004 x d ₁	60	0,003 x d ₁		<input checked="" type="checkbox"/>
	2.1	80	0,003 x d ₁	80	0,002 x d ₁		<input checked="" type="checkbox"/>
	2.2	30	0,003 x d ₁	30	0,002 x d ₁		<input checked="" type="checkbox"/>
	2.3	30	0,003 x d ₁	30	0,002 x d ₁		<input checked="" type="checkbox"/>
	2.4	30	0,003 x d ₁	30	0,002 x d ₁		<input checked="" type="checkbox"/>
2.5	30	0,003 x d ₁	30	0,002 x d ₁		<input checked="" type="checkbox"/>	
2.6	30	0,003 x d ₁	30	0,002 x d ₁		<input checked="" type="checkbox"/>	
H	1.1	130	0,004 x d ₁	130	0,003 x d ₁	<input type="checkbox"/>	<input checked="" type="checkbox"/>
	1.2	100	0,004 x d ₁	100	0,003 x d ₁	<input type="checkbox"/>	<input checked="" type="checkbox"/>
	1.3	80	0,003 x d ₁	80	0,002 x d ₁	<input type="checkbox"/>	<input checked="" type="checkbox"/>
	1.4						
	1.5						

v_c = Schnittgeschwindigkeit · Cutting speed
f_z = Vorschub pro Zahn · Feed per tooth

■ = sehr gut geeignet · very suitable
□ = gut geeignet · suitable

- Hochleistungswerkzeug
- Mit 3 Schneiden
- Vibrationsarme Bearbeitung
- Hocheffiziente Schlichtbearbeitung
- Formtoleranz $\pm 0,01$ mm
- High performance tool
- With 3 flutes
- Low-vibration machining
- Highly efficient finishing
- Form tolerance ± 0.01 mm

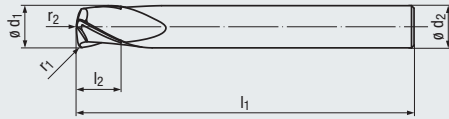
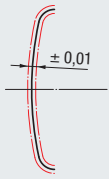

Design I₃:

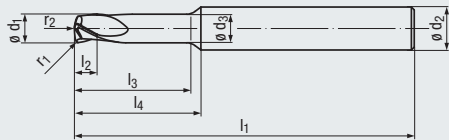

N

HM

DIN 6535
HA
HB

Form
 $\pm 0,01$

30°

Optional

Linsenform – ER
Lens Form – ER



Allround

Beschichtung · Coating

Einsatzgebiete – Material (siehe Seite 4)

- Speziell für hochfeste Werkstoffe geeignet
- In fast allen Werkstoffen einsetzbar
- Zum HSC-Schlichten geeignet

Applications – material (see page 4)

- Especially suitable for high-strength materials
- For almost all materials
- Suitable for HSC finishing

ALCR

P	1.1-5.1	
M	1.1-2.1	3.1-4.1
K	1.1-2.1	2.2
K	3.1-4.1	4.2
N	1.1-1.4	
N	2.1-3.2	5.2
S	1.1-2.1	

Bestell-Code · Order code

3544L

$\varnothing d_1$	r_1	r_2	l_2	l_3	l_1	$\varnothing d_3$	l_4	$\varnothing d_2$	Z (Flutes)	Dimens.- Code			
4	0,25	6	4	18	62	4	20	6	3	.04006A	●		
6	0,5	10	6	–	62	–	–	6	3	.06010A	●		
8	0,75	15	8	–	68	–	–	8	3	.08015A	●		
10	1	20	10	–	80	–	–	10	3	.10020A	●		
12	1,25	25	12	–	93	–	–	12	3	.12025A	●		

Bearbeitungsbeispiel

Bauteil: Integralbauteil aus der Luftfahrtindustrie

Anwendung: Schlichtbearbeitung der tiefen Taschen und der Bodenflächen

Machining example

Component: Integral component from the aviation industry

Application: Finishing of the deep pockets and the bottom surfaces



Hartmetall-Kreissegment-Fräser mit Linsenform – ER
Solid carbide circle segment end mill with lens form – ER

N

Gültig für · Valid for
3544L



Aufmaß · Allowance
0,05 - 0,1 mm



Aufmaß · Allowance
0,1 - 0,2 mm

Für die Berechnung der Drehzahl n muss mit dem Durchmesser d₁ gerechnet werden.

In order to calculate the rotational speed n, the diameter d₁ has to be used.



	V _c [m/min]	f _z [mm]	V _c [m/min]	f _z [mm]			MMS MQL		
P	1.1	420	0,004 x d ₁	420	0,003 x d ₁	<input type="checkbox"/>	<input checked="" type="checkbox"/>	<input type="checkbox"/>	<input checked="" type="checkbox"/>
	2.1	375	0,004 x d ₁	375	0,003 x d ₁	<input type="checkbox"/>	<input checked="" type="checkbox"/>	<input type="checkbox"/>	<input checked="" type="checkbox"/>
	3.1	315	0,003 x d ₁	315	0,003 x d ₁	<input type="checkbox"/>	<input checked="" type="checkbox"/>	<input type="checkbox"/>	<input checked="" type="checkbox"/>
	4.1	300	0,003 x d ₁	300	0,002 x d ₁	<input type="checkbox"/>	<input checked="" type="checkbox"/>		
	5.1	270	0,003 x d ₁	270	0,002 x d ₁	<input type="checkbox"/>	<input checked="" type="checkbox"/>		
M	1.1	150	0,005 x d ₁	150	0,003 x d ₁			<input type="checkbox"/>	<input checked="" type="checkbox"/>
	2.1	120	0,005 x d ₁	120	0,003 x d ₁			<input type="checkbox"/>	<input checked="" type="checkbox"/>
	3.1	90	0,004 x d ₁	90	0,002 x d ₁			<input type="checkbox"/>	<input checked="" type="checkbox"/>
	4.1	60	0,004 x d ₁	60	0,002 x d ₁			<input type="checkbox"/>	<input checked="" type="checkbox"/>
K	1.1	300	0,005 x d ₁	300	0,004 x d ₁	<input type="checkbox"/>	<input checked="" type="checkbox"/>		
	1.2	300	0,005 x d ₁	300	0,004 x d ₁	<input type="checkbox"/>	<input checked="" type="checkbox"/>		
	2.1	270	0,004 x d ₁	270	0,003 x d ₁	<input type="checkbox"/>	<input checked="" type="checkbox"/>		
	2.2	270	0,004 x d ₁	270	0,003 x d ₁	<input type="checkbox"/>	<input checked="" type="checkbox"/>		
	3.1	220	0,004 x d ₁	220	0,003 x d ₁	<input type="checkbox"/>	<input checked="" type="checkbox"/>		
	3.2	220	0,004 x d ₁	220	0,003 x d ₁	<input type="checkbox"/>	<input checked="" type="checkbox"/>		
	4.1	200	0,003 x d ₁	200	0,002 x d ₁	<input type="checkbox"/>	<input checked="" type="checkbox"/>		
	4.2	150	0,003 x d ₁	150	0,002 x d ₁	<input type="checkbox"/>	<input checked="" type="checkbox"/>		
N	1.1	900	0,004 x d ₁	900	0,003 x d ₁			<input type="checkbox"/>	<input checked="" type="checkbox"/>
	1.2	900	0,004 x d ₁	900	0,003 x d ₁			<input type="checkbox"/>	<input checked="" type="checkbox"/>
	1.3	900	0,003 x d ₁	900	0,002 x d ₁			<input type="checkbox"/>	<input checked="" type="checkbox"/>
	1.4	600	0,004 x d ₁	600	0,003 x d ₁			<input type="checkbox"/>	<input checked="" type="checkbox"/>
	1.5								
	1.6								
	2.1	270	0,004 x d ₁	270	0,003 x d ₁			<input type="checkbox"/>	<input checked="" type="checkbox"/>
	2.2	270	0,004 x d ₁	270	0,003 x d ₁			<input type="checkbox"/>	<input checked="" type="checkbox"/>
	2.3	270	0,004 x d ₁	270	0,003 x d ₁		<input type="checkbox"/>	<input type="checkbox"/>	<input checked="" type="checkbox"/>
	2.4	255	0,003 x d ₁	255	0,002 x d ₁		<input type="checkbox"/>	<input type="checkbox"/>	<input checked="" type="checkbox"/>
	2.5	255	0,003 x d ₁	255	0,002 x d ₁		<input type="checkbox"/>	<input type="checkbox"/>	<input checked="" type="checkbox"/>
	2.6	255	0,003 x d ₁	255	0,002 x d ₁		<input type="checkbox"/>	<input type="checkbox"/>	<input checked="" type="checkbox"/>
	2.7	150	0,003 x d ₁	150	0,002 x d ₁		<input type="checkbox"/>	<input type="checkbox"/>	<input checked="" type="checkbox"/>
	2.8	150	0,003 x d ₁	150	0,002 x d ₁		<input type="checkbox"/>	<input type="checkbox"/>	<input checked="" type="checkbox"/>
	3.1	600	0,004 x d ₁	600	0,003 x d ₁			<input type="checkbox"/>	<input checked="" type="checkbox"/>
	3.2	600	0,004 x d ₁	600	0,003 x d ₁			<input type="checkbox"/>	<input checked="" type="checkbox"/>
4.1									
4.2									
4.3									
4.4									
5.1									
5.2	150	0,005 x d ₁	150	0,003 x d ₁				<input checked="" type="checkbox"/>	
5.3									
S	1.1	150	0,006 x d ₁	150	0,004 x d ₁				<input checked="" type="checkbox"/>
	1.2	120	0,005 x d ₁	120	0,003 x d ₁				<input checked="" type="checkbox"/>
	1.3	90	0,005 x d ₁	90	0,003 x d ₁				<input checked="" type="checkbox"/>
	2.1	120	0,004 x d ₁	120	0,002 x d ₁				<input checked="" type="checkbox"/>
	2.2								
	2.3								
2.4									
2.5									
2.6									
H	1.1								
	1.2								
	1.3								
	1.4								
	1.5								

v_c = Schnittgeschwindigkeit · Cutting speed
f_z = Vorschub pro Zahn · Feed per tooth

■ = sehr gut geeignet · very suitable
□ = gut geeignet · suitable

- Hochleistungswerkzeug
- Mit 3 Schneiden
- Schruppverzahnung
- Ungleiche Teilung
- Vibrationsarme Bearbeitung
- Konuswinkel 4°

- High performance tool
- With 3 flutes
- Roughing profile
- Variable spacing
- Low-vibration machining
- Taper angle 4°

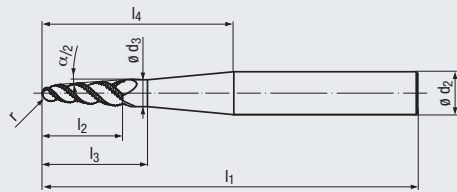
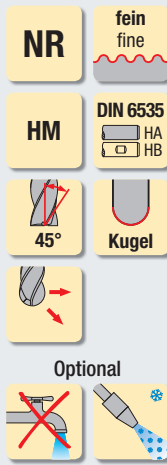

Allround

Beschichtung · Coating

ALCR

Einsatzgebiete – Material (siehe Seite 4)

Applications – material (see page 4)

- Speziell für schwer zerspanbare Werkstoffe geeignet
- In allen zähen Werkstoffen einsetzbar
- Optimiert zur Bearbeitung von Impellern und Integrated Bladed Rotors (IBR) aus Aluminium, Titan und Inconel

- Especially suitable for difficult to cut materials
- For all tough materials
- Optimised for machining Impellers and Integrated Bladed Rotors (IBR) made from aluminium, titanium and Inconel

P	1.1-5.1
M	1.1-4.1
N	1.1-1.3
S	1.1-1.3
S	2.2-2.6

Bestell-Code · Order code

3546L

$\alpha/2$	r	l_2	l_3	l_1	l_4	$\varnothing d_3$	$\varnothing d_2$ h6	Z (Flutes)	Dimens.- Code			
4°	2	20	27	80	37,7	6,5	8	3	.04020C	●		
	2	25	32	95	52	7,2	10	3	.04020B	●		
	2	30	37	120	66	7,9	12	3	.04020A	●		
	3	35	42	140	81	10,6	16	3	.04030A	●		
	4	40	46	155	96	13	20	3	.04040A	●		

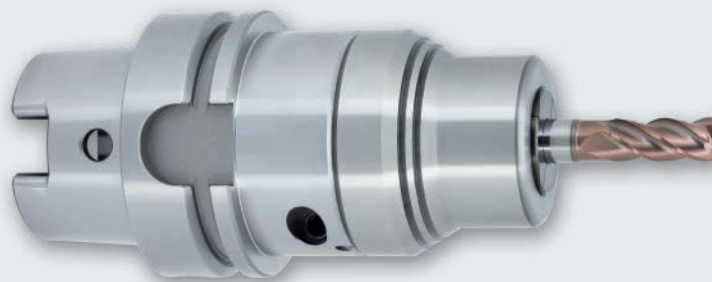

Präzisions-Spannhülsen-Aufnahmen FPC

High Precision Collet Holders FPC

Die patentierten Präzisions-Spannhülsen-Aufnahmen FPC sind hochgenaue Werkzeug-Aufnahmen mit mechanischer Klemmung für höchste Spannkraft und Rundlaufgenauigkeit sowie mit sehr guten Dämpfungseigenschaften. Die Werkzeugspannung erfolgt mittels Spannhülsen. Das Spannen und Lösen des Werkzeugs geschieht mit einem Sechskantschlüssel, welcher seitlich den Spannmechanismus bedient – und das innerhalb weniger Sekunden. Es können alle Zylinderschäfte nach DIN 6535 oder DIN 1835 gespannt werden. Die Präzisions-Spannhülsen-Aufnahmen FPC eignen sich hervorragend zum Hochleistungs- und Hochgeschwindigkeitsfräsen. Darüber hinaus können diese auch zum Bohren, Reiben oder zur Gewindeherstellung eingesetzt werden.

The patented precision collet holders FPC are highly precise tool holders with mechanical clamping which provide superior clamping force and concentricity as well as excellent shock-absorbing properties. The tools are clamped via collets. Tools are clamped and unclamped with a hexagon wrench which operates the clamping mechanism at the side – and in just a few seconds. All straight shanks according to DIN 6535 or DIN 1835 can be clamped. The high-precision collet holders FPC are well suited for high-performance and high-speed milling. In addition they can be used for drilling, reaming and threading operations.

Konische Hartmetall-Kugelfräser
Tapered solid carbide ball nose end mills

NR

Gültig für · Valid for
3546L

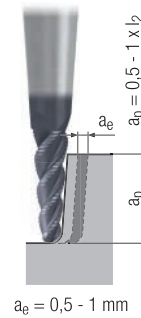

Für die Berechnung der Drehzahl n muss mit dem mittleren Durchmesser d_m (Messpunkt bei $0,5 \times a_p$) gerechnet werden.

For the calculation of rpm (n), use the average diameter d_m (measuring point at $0.5 \times a_p$).

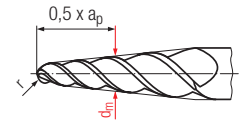

$$n = \frac{v_c \times 1000}{d_m \times \pi} \text{ [min}^{-1}\text{]}$$



	v_c [m/min]	f_z [mm]	v_c [m/min]	f_z [mm]					
P	1.1	100	0,014 x r	120	0,018 x r		■	□	■
	2.1	90	0,012 x r	110	0,016 x r		■	□	■
	3.1	90	0,010 x r	100	0,014 x r		■	□	■
	4.1	80	0,010 x r	100	0,012 x r		■	□	■
	5.1	70	0,010 x r	90	0,012 x r		■	□	■
M	1.1	100	0,014 x r	120	0,018 x r				■
	2.1	100	0,013 x r	100	0,016 x r				■
	3.1	70	0,012 x r	70	0,014 x r				■
	4.1	70	0,010 x r	70	0,012 x r				■
K	1.1								
	1.2								
	2.1								
	2.2								
	3.1								
	3.2								
	4.1								
N	1.1	280	0,020 x r	400	0,030 x r				■
	1.2	200	0,025 x r	280	0,030 x r				■
	1.3	140	0,030 x r	200	0,030 x r				■
	1.4								
	1.5								
	1.6								
	2.1								
	2.2								
	2.3								
	2.4								
	2.5								
	2.6								
	2.7								
	2.8								
	3.1								
	3.2								
4.1									
4.2									
4.3									
4.4									
5.1									
5.2									
5.3									
S	1.1	90	0,015 x r	100	0,020 x r				■
	1.2	75	0,012 x r	80	0,017 x r				■
	1.3	45	0,010 x r	60	0,015 x r				■
	2.1								
	2.2	25	0,010 x r	30	0,018 x r				■
	2.3	25	0,010 x r	30	0,016 x r				■
	2.4	25	0,010 x r	30	0,014 x r				■
2.5	15	0,010 x r	20	0,012 x r				■	
2.6	25	0,010 x r	30	0,012 x r				■	
H	1.1								
	1.2								
	1.3								
	1.4								
	1.5								

v_c = Schnittgeschwindigkeit · Cutting speed
 f_z = Vorschub pro Zahn · Feed per tooth

■ = sehr gut geeignet · very suitable
□ = gut geeignet · suitable

- Multifunktionales Werkzeug
- Feine Schruppschicht-Verzahnung
- Mit 2 Schneiden
- Verschiedene Kegelwinkel
- Auch mit poliertem Spanraum erhältlich

- Multi-functional tool
- Fine semi-finishing profile
- With 2 flutes
- Various taper angles
- Also available with polished chip space

NF fein fine

HM DIN 6535 HA HB

30° Kugel

Optional

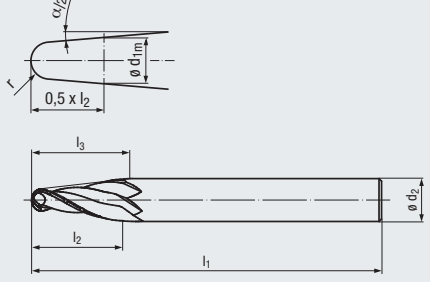

Design I₄:

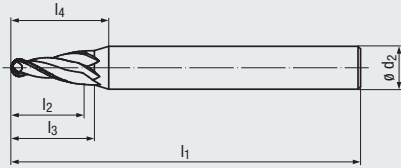

Mit poliertem Spanraum
With polished chip space

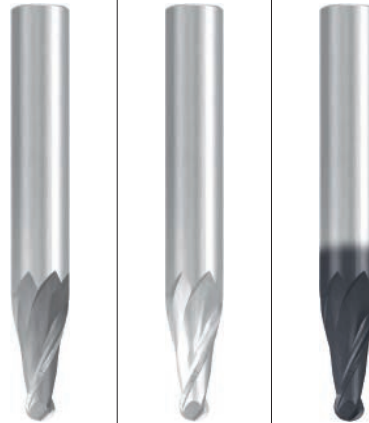

Allround

Allround

Beschichtung · Coating

Einsatzgebiete – Material (siehe Seite 4)

- In fast allen Werkstoffen einsetzbar
- Zum Schruppen und Schlichten geeignet

Applications – material (see page 4)

- For almost all materials
- Suitable for roughing and finishing

ALCR

N	1.1-1.3	
N	4.1-4.2	
P	1.1-3.1	4.1-5.1
M	1.1-2.1	
K	1.1-2.2	3.1-4.2
N	1.1-1.4	1.5
N	2.1-2.6	2.7-2.8
N	3.1-4.4, 5.2-5.3	
S	1.1-1.2	1.3
S	2.1-2.2	2.3-2.6

Bestell-Code · Order code

$\alpha/2$	r <small>±0,01</small>	l ₂	l ₃	l ₁	l ₄	d _{1m}	ø d ₂ h6	Z (Flutes)	Dimens.- Code	3446	3447	3446L
3°	1,5	20	20	62	24	3,90	6	2	.03015A	●	●	●
	2	31	31	80	35	5,42	8	2	.03020B	●	●	●
4°	0,5	20	20	62	24	2,33	6	2	.04005A	●	●	●
	1	20	20	62	24	3,26	6	2	.04010A	●	●	●
	1,5	20	20	63	25	4,20	8	2	.04015A	●	●	●
	2	30	30	72	-	5,83	8	2	.04020B	●	●	●
6°	0,5	20	24	62	-	3,00	6	2	.06005A	●	●	●
	1	19	19	62	-	3,80	6	2	.06010A	●	●	●
	1,5	15	15	62	-	4,28	6	2	.06015A	●	●	●
	1,5	25	25	68	-	5,33	8	2	.06015B	●	●	●
	2	20	20	68	-	5,70	8	2	.06020A	●	●	●
	2	30	30	80	-	6,76	10	2	.06020B	●	●	●
8°	0,5	18	18	62	-	3,40	6	2	.08005A	●	●	●
	1	15	15	62	-	3,85	6	2	.08010A	●	●	●
	1,5	19	19	63	-	5,28	8	2	.08015A	●	●	●
	2	23	23	72	-	6,71	10	2	.08020A	●	●	●

Konische Hartmetall-Kugelfräser
Tapered solid carbide ball nose end mills

NF

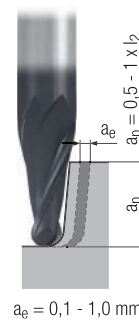
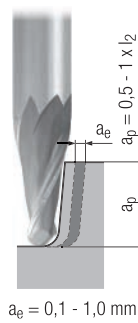
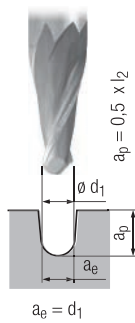

Gültig für · Valid for
3446 3446L 3447

Für die Berechnung der Drehzahl n muss mit dem mittleren Durchmesser d_m (Messpunkt bei $0,5 \times a_p$) gerechnet werden.

For the calculation of rpm (n), use the average diameter d_m (measuring point at $0,5 \times a_p$).

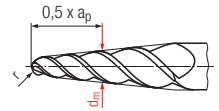

$$n = \frac{v_c \times 1000}{d_m \times \pi} \text{ [min}^{-1}\text{]}$$

Unbeschichtet · Uncoated

ALCR



	v_c [m/min]	f_z [mm]	Unbeschichtet · Uncoated		ALCR					
			v_c [m/min]	f_z [mm]	v_c [m/min]	f_z [mm]				
P	1.1				160	$0,010 \times r$	<input type="checkbox"/>	<input checked="" type="checkbox"/>	<input type="checkbox"/>	<input checked="" type="checkbox"/>
	2.1				140	$0,010 \times r$	<input type="checkbox"/>	<input checked="" type="checkbox"/>	<input type="checkbox"/>	<input checked="" type="checkbox"/>
	3.1				120	$0,008 \times r$	<input type="checkbox"/>	<input checked="" type="checkbox"/>	<input type="checkbox"/>	<input type="checkbox"/>
	4.1				100	$0,008 \times r$	<input type="checkbox"/>	<input checked="" type="checkbox"/>	<input type="checkbox"/>	<input type="checkbox"/>
	5.1				80	$0,006 \times r$	<input type="checkbox"/>	<input checked="" type="checkbox"/>	<input type="checkbox"/>	<input type="checkbox"/>
M	1.1				80	$0,006 \times r$			<input type="checkbox"/>	<input checked="" type="checkbox"/>
	2.1				70	$0,006 \times r$			<input type="checkbox"/>	<input checked="" type="checkbox"/>
	3.1								<input type="checkbox"/>	<input checked="" type="checkbox"/>
	4.1								<input type="checkbox"/>	<input checked="" type="checkbox"/>
K	1.1				160	$0,010 \times r$	<input checked="" type="checkbox"/>	<input checked="" type="checkbox"/>		
	1.2				160	$0,010 \times r$	<input checked="" type="checkbox"/>	<input checked="" type="checkbox"/>		
	2.1				140	$0,008 \times r$	<input checked="" type="checkbox"/>	<input checked="" type="checkbox"/>		
	2.2				140	$0,008 \times r$	<input checked="" type="checkbox"/>	<input checked="" type="checkbox"/>		
	3.1				120	$0,008 \times r$	<input checked="" type="checkbox"/>	<input checked="" type="checkbox"/>		
	3.2				120	$0,008 \times r$	<input checked="" type="checkbox"/>	<input checked="" type="checkbox"/>		
	4.1				100	$0,006 \times r$	<input checked="" type="checkbox"/>	<input checked="" type="checkbox"/>		
	4.2				80	$0,006 \times r$	<input checked="" type="checkbox"/>	<input checked="" type="checkbox"/>		
N	1.1	350	$0,040 \times r$	300	$0,020 \times r$	350	$0,016 \times r$		<input type="checkbox"/>	<input checked="" type="checkbox"/>
	1.2	350	$0,040 \times r$	300	$0,020 \times r$	350	$0,014 \times r$		<input type="checkbox"/>	<input checked="" type="checkbox"/>
	1.3	320	$0,035 \times r$	270	$0,017 \times r$	350	$0,012 \times r$		<input type="checkbox"/>	<input checked="" type="checkbox"/>
	1.4					280	$0,014 \times r$		<input type="checkbox"/>	<input checked="" type="checkbox"/>
	1.5					240	$0,012 \times r$		<input type="checkbox"/>	<input checked="" type="checkbox"/>
	1.6								<input type="checkbox"/>	<input checked="" type="checkbox"/>
	2.1					140	$0,010 \times r$		<input type="checkbox"/>	<input checked="" type="checkbox"/>
	2.2					140	$0,010 \times r$		<input type="checkbox"/>	<input checked="" type="checkbox"/>
	2.3					140	$0,010 \times r$	<input type="checkbox"/>	<input type="checkbox"/>	<input checked="" type="checkbox"/>
	2.4					120	$0,008 \times r$	<input type="checkbox"/>	<input type="checkbox"/>	<input checked="" type="checkbox"/>
	2.5					120	$0,008 \times r$	<input type="checkbox"/>	<input type="checkbox"/>	<input checked="" type="checkbox"/>
	2.6					120	$0,008 \times r$	<input type="checkbox"/>	<input type="checkbox"/>	<input checked="" type="checkbox"/>
	2.7					70	$0,006 \times r$	<input type="checkbox"/>	<input type="checkbox"/>	<input checked="" type="checkbox"/>
	2.8					70	$0,006 \times r$	<input type="checkbox"/>	<input type="checkbox"/>	<input checked="" type="checkbox"/>
	3.1					320	$0,018 \times r$		<input type="checkbox"/>	<input checked="" type="checkbox"/>
	3.2					320	$0,014 \times r$		<input type="checkbox"/>	<input checked="" type="checkbox"/>
4.1			180	$0,016 \times r$	240	$0,016 \times r$		<input type="checkbox"/>	<input checked="" type="checkbox"/>	
4.2			160	$0,016 \times r$	350	$0,016 \times r$		<input type="checkbox"/>	<input checked="" type="checkbox"/>	
4.3					180	$0,012 \times r$		<input type="checkbox"/>	<input checked="" type="checkbox"/>	
4.4					90	$0,012 \times r$		<input type="checkbox"/>	<input checked="" type="checkbox"/>	
5.1								<input type="checkbox"/>	<input checked="" type="checkbox"/>	
5.2					80	$0,006 \times r$		<input type="checkbox"/>	<input checked="" type="checkbox"/>	
5.3					160	$0,012 \times r$	<input type="checkbox"/>	<input checked="" type="checkbox"/>	<input checked="" type="checkbox"/>	
S	1.1				80	$0,008 \times r$			<input type="checkbox"/>	<input checked="" type="checkbox"/>
	1.2				60	$0,006 \times r$			<input type="checkbox"/>	<input checked="" type="checkbox"/>
	1.3				40	$0,006 \times r$			<input type="checkbox"/>	<input checked="" type="checkbox"/>
	2.1				50	$0,006 \times r$			<input type="checkbox"/>	<input checked="" type="checkbox"/>
	2.2				20	$0,004 \times r$			<input type="checkbox"/>	<input checked="" type="checkbox"/>
	2.3				20	$0,004 \times r$			<input type="checkbox"/>	<input checked="" type="checkbox"/>
2.4				20	$0,004 \times r$			<input type="checkbox"/>	<input checked="" type="checkbox"/>	
2.5				15	$0,004 \times r$			<input type="checkbox"/>	<input checked="" type="checkbox"/>	
2.6				20	$0,004 \times r$			<input type="checkbox"/>	<input checked="" type="checkbox"/>	
H	1.1									
	1.2									
	1.3									
	1.4									
	1.5									

v_c = Schnittgeschwindigkeit · Cutting speed
 f_z = Vorschub pro Zahn · Feed per tooth

= sehr gut geeignet · very suitable
 = gut geeignet · suitable

- Multifunktionales Werkzeug
- Mit 2 Schneiden
- Verschiedene Kegelwinkel
- Auch mit poliertem Spanraum erhältlich

- Multi-functional tool
- With 2 flutes
- Various taper angles
- Also available with polished chip space

N

HM

DIN 6535

HA
HB

30°

Kugel

Optional

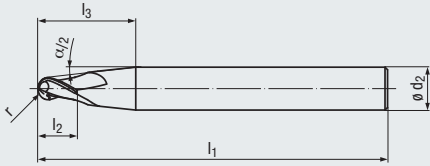

Design I4:

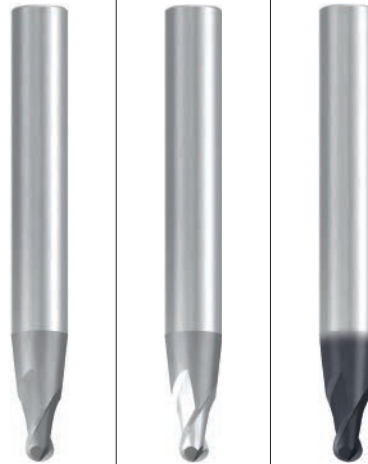
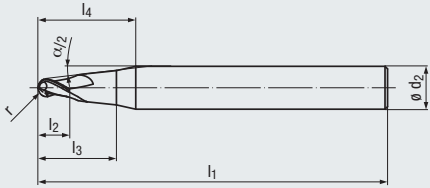

Mit poliertem Spanraum
With polished chip space

Allround

Allround

Beschichtung · Coating

Einsatzgebiete – Material (siehe Seite 4)

- In fast allen Werkstoffen einsetzbar
- Zum Schruppen und Schlichten geeignet

Applications – material (see page 4)

- For almost all materials
- Suitable for roughing and finishing

ALCR

N 1.1-1.3
N 4.1-4.2

P 1.1-3.1 4.1-5.1
M 1.1-2.1
K 1.1-2.2 3.1-4.2
N 1.1-1.4 1.5
N 2.1-2.6 2.7-2.8
N 3.1-4.4, 5.2-5.3
S 1.1-1.2 1.3
S 2.1-2.2 2.3-2.6

Bestell-Code · Order code

3442

3443

3442L

$\alpha/2$	r	l ₂	l ₃	l ₁	l ₄	ϕd_2 h6	Z (Flutes)	Dimens.- Code	3442	3443	3442L	
3°	1,5	4	24	63	26	8	2	.03015A	●	●	●	
	3	7	38	80	39	10	2	.03030A	●	●	●	
4°	1,5	4	24	63	26	8	2	.04015A	●	●	●	
	3	7	33	80	–	10	2	.04030A	●	●	●	
6°	1,5	4	26	63	–	8	2	.06015A	●	●	●	
	3	7	23	80	–	10	2	.06030A	●	●	●	
8°	1,5	4	27	80	–	10	2	.08015A	●	●	●	
	3	7	25	83	–	12	2	.08030A	●	●	●	

Konische Hartmetall-Kugelfräser
Tapered solid carbide ball nose end mills

N

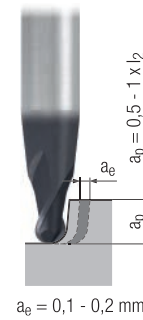
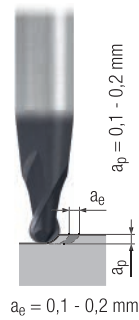
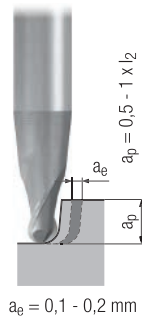
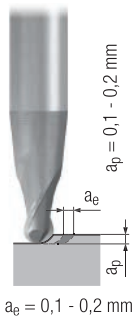

Gültig für · Valid for
3442 3442L 3443

Für die Berechnung der Drehzahl n muss mit dem mittleren Durchmesser d_m (Messpunkt bei $0,5 \times a_p$) gerechnet werden.

For the calculation of rpm (n), use the average diameter d_m (measuring point at $0,5 \times a_p$).

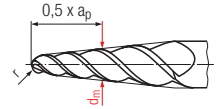

$$n = \frac{v_c \times 1000}{d_m \times \pi} \text{ [min}^{-1}\text{]}$$

Unbeschichtet · Uncoated

ALCR



	Unbeschichtet · Uncoated				ALCR								
	v_c [m/min]	f_z [mm]	v_c [m/min]	f_z [mm]	v_c [m/min]	f_z [mm]	v_c [m/min]	f_z [mm]					
P	1.1				300	0,010 x r	160	0,010 x r	□	■	□	■	
	2.1				260	0,010 x r	140	0,010 x r	□	■	□	■	
	3.1				220	0,008 x r	120	0,008 x r	□	■	□	■	
	4.1				180	0,008 x r	100	0,008 x r	□	■	□	■	
	5.1				150	0,006 x r	80	0,006 x r	□	■	□	■	
M	1.1				150	0,006 x r	80	0,006 x r			□	■	
	2.1				120	0,006 x r	70	0,006 x r			□	■	
	3.1										□	■	
	4.1										□	■	
K	1.1				300	0,010 x r	160	0,010 x r	■	■			
	1.2				300	0,010 x r	160	0,010 x r	■	■			
	2.1				260	0,008 x r	140	0,008 x r	■	■			
	2.2				260	0,008 x r	140	0,008 x r	■	■			
	3.1				220	0,008 x r	120	0,008 x r	■	■			
	3.2				220	0,008 x r	120	0,008 x r	■	■			
	4.1				180	0,006 x r	100	0,006 x r	■	■			
	4.2				150	0,006 x r	80	0,006 x r	■	■			
N	1.1	490	0,016 x r	250	0,016 x r	700	0,016 x r	350	0,016 x r		□	■	
	1.2	490	0,014 x r	250	0,014 x r	700	0,014 x r	350	0,014 x r		□	■	
	1.3	490	0,012 x r	250	0,012 x r	700	0,012 x r	350	0,012 x r		□	■	
	1.4					500	0,014 x r	280	0,014 x r		□	■	
	1.5					450	0,012 x r	240	0,012 x r		□	■	
	1.6										□	■	
	2.1					260	0,010 x r	140	0,010 x r			□	■
	2.2					260	0,010 x r	140	0,010 x r			□	■
	2.3					260	0,010 x r	140	0,010 x r	□	□	□	■
	2.4					220	0,008 x r	120	0,008 x r			□	■
	2.5					220	0,008 x r	120	0,008 x r			□	■
	2.6					220	0,008 x r	120	0,008 x r	□	□	□	■
	2.7					140	0,006 x r	70	0,006 x r			□	■
	2.8					140	0,006 x r	70	0,006 x r			□	■
	3.1					600	0,018 x r	320	0,018 x r			□	■
	3.2					600	0,014 x r	320	0,014 x r			□	■
4.1	320	0,016 x r	170	0,016 x r	460	0,016 x r	240	0,016 x r		□	□	■	
4.2	460	0,016 x r	250	0,016 x r	650	0,016 x r	350	0,016 x r		□	□	■	
4.3					250	0,012 x r	180	0,012 x r		□	□	■	
4.4					180	0,012 x r	90	0,012 x r		□	□	■	
5.1											□	■	
5.2					180	0,006 x r	80	0,006 x r			□	■	
5.3					300	0,012 x r	160	0,012 x r	□	■		■	
S	1.1				150	0,008 x r	80	0,008 x r			□	■	
	1.2				120	0,006 x r	60	0,006 x r			□	■	
	1.3				70	0,006 x r	40	0,006 x r			□	■	
	2.1				110	0,006 x r	50	0,006 x r			□	■	
	2.2				30	0,004 x r	20	0,004 x r			□	■	
	2.3				30	0,004 x r	20	0,004 x r			□	■	
	2.4				30	0,004 x r	20	0,004 x r			□	■	
2.5				20	0,004 x r	15	0,004 x r			□	■		
2.6				30	0,004 x r	20	0,004 x r			□	■		
H	1.1												
	1.2												
	1.3												
	1.4												
	1.5												

v_c = Schnittgeschwindigkeit · Cutting speed
 f_z = Vorschub pro Zahn · Feed per tooth

■ = sehr gut geeignet · very suitable
□ = gut geeignet · suitable

- Multifunktionales Werkzeug
- Mit 3 Schneiden
- Verschiedene Kegelwinkel
- Auch mit poliertem Spanraum erhältlich
- Multi-functional tool
- With 3 flutes
- Various taper angles
- Also available with polished chip space

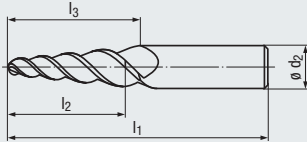
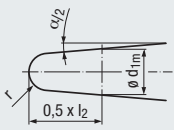

Design I₄:

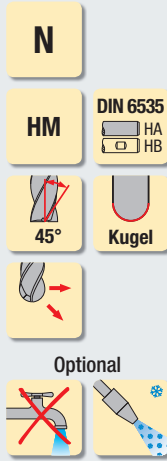
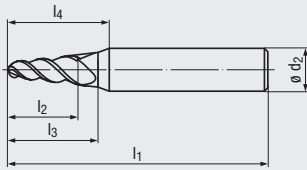

Mit poliertem Spanraum
With polished chip space

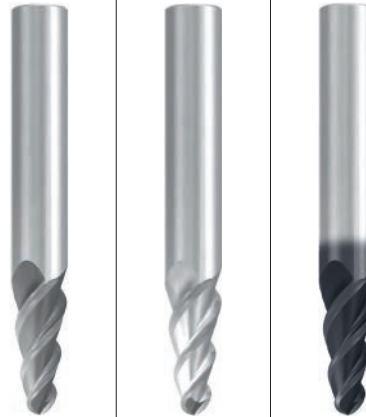

Allround

Allround

Beschichtung · Coating

Einsatzgebiete – Material (siehe Seite 4)

- In fast allen Werkstoffen einsetzbar
- Zum Schlichten geeignet

Applications – material (see page 4)

- For almost all materials
- Suitable for finishing

ALCR

N 1.1-1.3
N 4.1-4.2

P 1.1-3.1 4.1-5.1
M 1.1-2.1
K 1.1-2.2 3.1-4.2
N 1.1-1.4 1.5
N 2.1-2.6 2.7-2.8
N 3.1-4.4, 5.2-5.3
S 1.1-1.2 1.3
S 2.1-2.2 2.3-2.6

Bestell-Code · Order code

$\alpha/2$	r <small>±0,005</small>	l ₂	l ₃	l ₁	l ₄	d _{1m}	ø d ₂ h6	Z (Flutes)	Dimens.- Code	3440	3441	3440L
3°	1,5	20	20	62	24	3,90	6	3	.03015A	●	●	●
	2	21	21	66	–	4,90	6	3	.03020A	●	●	●
	2	31	31	80	35	5,42	8	3	.03020B	●	●	●
	3	22	22	72	–	6,85	8	3	.03030A	●	●	●
	3	31	31	80	35	7,32	10	3	.03030B	●	●	●
4°	0,5	20	20	62	24	2,33	6	3	.04005A	●	●	●
	1	20	20	62	24	3,26	6	3	.04010A	●	●	●
	1,5	20	20	63	25	4,20	8	3	.04015A	●	●	●
	2	20	30	68	–	5,13	8	3	.04020A	●	●	●
	2	30	30	72	–	5,83	8	3	.04020B	●	●	●
	3	25	31	72	–	7,34	10	3	.04030A	●	●	●
6°	0,5	20	24	62	–	3,00	6	3	.06005A	●	●	●
	1	19	19	62	–	3,80	6	3	.06010A	●	●	●
	1	29	29	72	–	4,85	8	3	.06010B	●	●	●
	1,5	15	15	62	–	4,28	6	3	.06015A	●	●	●
	1,5	25	25	68	–	5,33	8	3	.06015B	●	●	●
	2	20	20	68	–	5,70	8	3	.06020A	●	●	●
	2	30	30	80	–	6,76	10	3	.06020B	●	●	●
8°	0,5	18	18	62	–	3,40	6	3	.08005A	●	●	●
	1	15	15	62	–	3,85	6	3	.08010A	●	●	●
	1	22	22	63	–	4,83	8	3	.08010B	●	●	●
	1,5	19	19	63	–	5,28	8	3	.08015A	●	●	●
	1,5	26	26	72	–	6,26	10	3	.08015B	●	●	●
17,5°	0,5	8	8	57	–	3,26	6	3	.17505A	●	●	●

Konische Hartmetall-Kugelfräser
Tapered solid carbide ball nose end mills

N

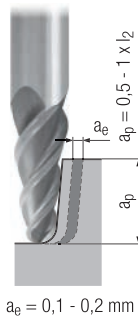

$a_e = 0,1 - 0,2 \text{ mm}$

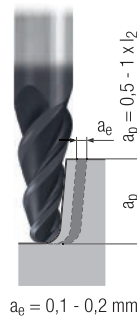

$a_e = 0,1 - 0,2 \text{ mm}$

Gültig für · Valid for
3440 3440L 3441

Für die Berechnung der Drehzahl n muss mit dem mittleren Durchmesser d_m (Messpunkt bei $0,5 \times a_p$) gerechnet werden.

For the calculation of rpm (n), use the average diameter d_m (measuring point at $0,5 \times a_p$).

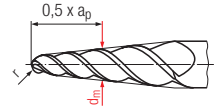

$$n = \frac{v_c \times 1000}{d_m \times \pi} \text{ [min}^{-1}\text{]}$$

Unbeschichtet · Uncoated

ALCR

v_c
[m/min]

f_z
[mm]

v_c
[m/min]

f_z
[mm]



	Unbeschichtet · Uncoated		ALCR						
	v_c [m/min]	f_z [mm]	v_c [m/min]	f_z [mm]					
P	1.1		120	0,010 x r	<input type="checkbox"/>	<input checked="" type="checkbox"/>	<input type="checkbox"/>	<input checked="" type="checkbox"/>	
	2.1		100	0,010 x r	<input type="checkbox"/>	<input checked="" type="checkbox"/>	<input type="checkbox"/>	<input checked="" type="checkbox"/>	
	3.1		90	0,008 x r	<input type="checkbox"/>	<input checked="" type="checkbox"/>	<input type="checkbox"/>	<input checked="" type="checkbox"/>	
	4.1		70	0,008 x r	<input type="checkbox"/>	<input checked="" type="checkbox"/>	<input type="checkbox"/>	<input checked="" type="checkbox"/>	
	5.1		60	0,006 x r	<input type="checkbox"/>	<input checked="" type="checkbox"/>	<input type="checkbox"/>	<input checked="" type="checkbox"/>	
M	1.1		60	0,006 x r			<input type="checkbox"/>	<input checked="" type="checkbox"/>	
	2.1		50	0,006 x r			<input type="checkbox"/>	<input checked="" type="checkbox"/>	
	3.1						<input type="checkbox"/>	<input checked="" type="checkbox"/>	
	4.1						<input type="checkbox"/>	<input checked="" type="checkbox"/>	
K	1.1		120	0,010 x r	<input checked="" type="checkbox"/>	<input checked="" type="checkbox"/>			
	1.2		120	0,010 x r	<input checked="" type="checkbox"/>	<input checked="" type="checkbox"/>			
	2.1		100	0,008 x r	<input checked="" type="checkbox"/>	<input checked="" type="checkbox"/>			
	2.2		100	0,008 x r	<input checked="" type="checkbox"/>	<input checked="" type="checkbox"/>			
	3.1		90	0,008 x r	<input checked="" type="checkbox"/>	<input checked="" type="checkbox"/>			
	3.2		90	0,008 x r	<input checked="" type="checkbox"/>	<input checked="" type="checkbox"/>			
	4.1		70	0,006 x r	<input checked="" type="checkbox"/>	<input checked="" type="checkbox"/>			
	4.2		60	0,006 x r	<input checked="" type="checkbox"/>	<input checked="" type="checkbox"/>			
N	1.1	180	0,016 x r	260	0,016 x r			<input type="checkbox"/>	<input checked="" type="checkbox"/>
	1.2	180	0,014 x r	260	0,014 x r			<input type="checkbox"/>	<input checked="" type="checkbox"/>
	1.3	180	0,012 x r	260	0,012 x r			<input type="checkbox"/>	<input checked="" type="checkbox"/>
	1.4			200	0,014 x r			<input type="checkbox"/>	<input checked="" type="checkbox"/>
	1.5			180	0,012 x r			<input type="checkbox"/>	<input checked="" type="checkbox"/>
	1.6							<input type="checkbox"/>	<input checked="" type="checkbox"/>
	2.1			100	0,010 x r			<input type="checkbox"/>	<input checked="" type="checkbox"/>
	2.2			100	0,010 x r			<input type="checkbox"/>	<input checked="" type="checkbox"/>
	2.3			100	0,010 x r	<input type="checkbox"/>	<input type="checkbox"/>	<input type="checkbox"/>	<input checked="" type="checkbox"/>
	2.4			80	0,008 x r			<input type="checkbox"/>	<input checked="" type="checkbox"/>
	2.5			80	0,008 x r			<input type="checkbox"/>	<input checked="" type="checkbox"/>
	2.6			80	0,008 x r	<input type="checkbox"/>	<input type="checkbox"/>	<input type="checkbox"/>	<input checked="" type="checkbox"/>
	2.7			50	0,006 x r			<input type="checkbox"/>	<input checked="" type="checkbox"/>
	2.8			50	0,006 x r			<input type="checkbox"/>	<input checked="" type="checkbox"/>
	3.1			240	0,018 x r			<input type="checkbox"/>	<input checked="" type="checkbox"/>
	3.2			240	0,014 x r			<input type="checkbox"/>	<input checked="" type="checkbox"/>
4.1	130	0,016 x r	180	0,016 x r			<input type="checkbox"/>	<input checked="" type="checkbox"/>	
4.2	110	0,016 x r	160	0,016 x r			<input type="checkbox"/>	<input checked="" type="checkbox"/>	
4.3			100	0,012 x r			<input type="checkbox"/>	<input checked="" type="checkbox"/>	
4.4			70	0,012 x r			<input type="checkbox"/>	<input checked="" type="checkbox"/>	
5.1							<input type="checkbox"/>	<input checked="" type="checkbox"/>	
5.2			60	0,006 x r			<input type="checkbox"/>	<input checked="" type="checkbox"/>	
5.3			120	0,012 x r	<input type="checkbox"/>	<input checked="" type="checkbox"/>		<input checked="" type="checkbox"/>	
S	1.1		60	0,008 x r			<input type="checkbox"/>	<input checked="" type="checkbox"/>	
	1.2		50	0,006 x r			<input type="checkbox"/>	<input checked="" type="checkbox"/>	
	1.3		30	0,006 x r			<input type="checkbox"/>	<input checked="" type="checkbox"/>	
	2.1			40	0,006 x r			<input type="checkbox"/>	<input checked="" type="checkbox"/>
	2.2			15	0,004 x r			<input type="checkbox"/>	<input checked="" type="checkbox"/>
	2.3			15	0,004 x r			<input type="checkbox"/>	<input checked="" type="checkbox"/>
	2.4			15	0,004 x r			<input type="checkbox"/>	<input checked="" type="checkbox"/>
2.5			10	0,004 x r			<input type="checkbox"/>	<input checked="" type="checkbox"/>	
2.6			15	0,004 x r			<input type="checkbox"/>	<input checked="" type="checkbox"/>	
H	1.1								
	1.2								
	1.3								
	1.4								
	1.5								

v_c = Schnittgeschwindigkeit · Cutting speed
 f_z = Vorschub pro Zahn · Feed per tooth

= sehr gut geeignet · very suitable
 = gut geeignet · suitable

- Hochleistungswerkzeug
- Mit 3 Schneiden
- Schlichtgeometrie
- High performance tool
- With 3 flutes
- Finishing geometry

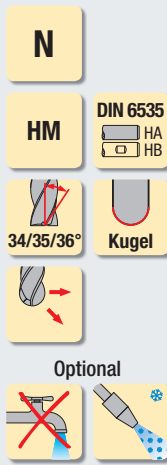

Allround

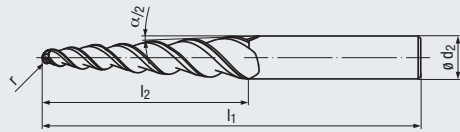

Beschichtung · Coating

- Einsatzgebiete – Material (siehe Seite 4)
- Speziell für schwer zerspanbare Werkstoffe geeignet
 - In allen zähen Werkstoffen einsetzbar

- Applications – material (see page 4)
- Especially suitable for difficult to cut materials
 - For all tough materials

ALCR

- P 1.1-5.1
- M 1.1-4.1
- N 1.3-1.5
- S 1.1-1.3
- S 2.2-2.6

Bestell-Code · Order code

3550L

$\alpha/2$	r $\pm 0,01$	l_2	l_1	ϕd_2 h6	Z (Flutes)	Dimens.- Code			
4°	2	59	120	12	3	.04020A	●		
	2	87	150	16	3	.04020B	●		
	3	74	140	16	3	.04030A	●		
	3	103	165	20	3	.04030B	●		
	4	89	155	20	3	.04040A	●		



Sie haben Fragen zu einem unserer Produkte?
Sprechen Sie doch einfach den für Sie zuständigen
EMUGE-FRANKEN Vertriebspartner an.

www.emuge-franken.com/vertrieb

Do you have questions about one of our products?
Just ask your EMUGE-FRANKEN sales contact.

www.emuge-franken.com/sales

Konische Hartmetall-Kugelfräser
Tapered solid carbide ball nose end mills

N

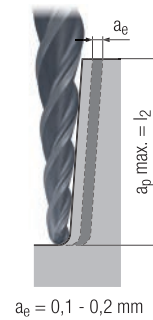

Gültig für · Valid for
3550L

Für die Berechnung der Drehzahl n muss mit dem mittleren Durchmesser d_m (Messpunkt bei $0,5 \times a_p$) gerechnet werden.

For the calculation of rpm (n), use the average diameter d_m (measuring point at $0,5 \times a_p$).

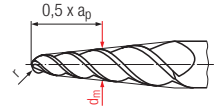

$$n = \frac{v_c \times 1000}{d_m \times \pi} \text{ [min}^{-1}\text{]}$$



	v_c [m/min]	f_z [mm]	v_c [m/min]	f_z [mm]					
P	1.1	120	0,07	80	0,05		■	□	■
	2.1	110	0,06	70	0,05		■	□	■
	3.1	100	0,05	60	0,04		■	□	■
	4.1	90	0,04	60	0,04		■		
	5.1	80	0,04	50	0,03		■		
M	1.1	90	0,07	60	0,03				■
	2.1	90	0,07	60	0,03				■
	3.1	70	0,07	50	0,03				■
	4.1	70	0,07	50	0,03				■
K	1.1								
	1.2								
	2.1								
	2.2								
	3.1								
	3.2								
	4.1								
4.2									
N	1.1								
	1.2								
	1.3	280	0,12	200	0,06				■
	1.4	200	0,12	140	0,06				■
	1.5	140	0,12	100	0,06				■
	1.6								
	2.1								
	2.2								
	2.3								
	2.4								
	2.5								
	2.6								
	2.7								
	2.8								
	3.1								
	3.2								
4.1									
4.2									
4.3									
4.4									
5.1									
5.2									
5.3									
S	1.1	90	0,07	60	0,03				■
	1.2	75	0,07	50	0,03				■
	1.3	45	0,07	30	0,03				■
	2.1								
	2.2	25	0,07	15	0,03				■
	2.3	25	0,07	15	0,03				■
	2.4	25	0,07	15	0,03				■
2.5	15	0,07	10	0,03				■	
2.6	25	0,07	15	0,03				■	
H	1.1								
	1.2								
	1.3								
	1.4								
	1.5								

v_c = Schnittgeschwindigkeit · Cutting speed
 f_z = Vorschub pro Zahn · Feed per tooth

■ = sehr gut geeignet · very suitable
□ = gut geeignet · suitable

- Hochleistungswerkzeug
- Mit 3 Schneiden im Radius
- 6 Umfangsschneiden

- High performance tool
- 3 flutes in the ball nose section
- 6 radial flutes

N

HM **DIN 6535**
HA
HB

38° **Kugel**

Optional



Allround

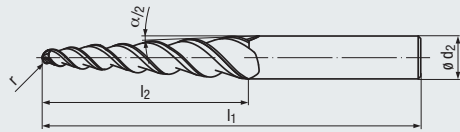

Beschichtung · Coating

ALCR

Einsatzgebiete – Material (siehe Seite 4)

Applications – material (see page 4)

- Speziell für schwer zerspanbare Werkstoffe geeignet
- In allen zähen Werkstoffen einsetzbar

- Especially suitable for difficult to cut materials
- For all tough materials

- P** 1.1-5.1
- M** 1.1-4.1
- N** 1.3-1.5
- S** 1.1-1.3
- S** 2.2-2.6

Bestell-Code · Order code

3548L

$\alpha/2$	r $\pm 0,01$	l_2	l_1	ϕd_2 h6	Z (Flutes)	Dimens.- Code			
4°	2	59	120	12	3/6	.04020A	●		
	2	87	150	16	3/6	.04020B	●		
	3	74	140	16	3/6	.04030A	●		
	3	103	165	20	3/6	.04030B	●		
	4	89	155	20	3/6	.04040A	●		

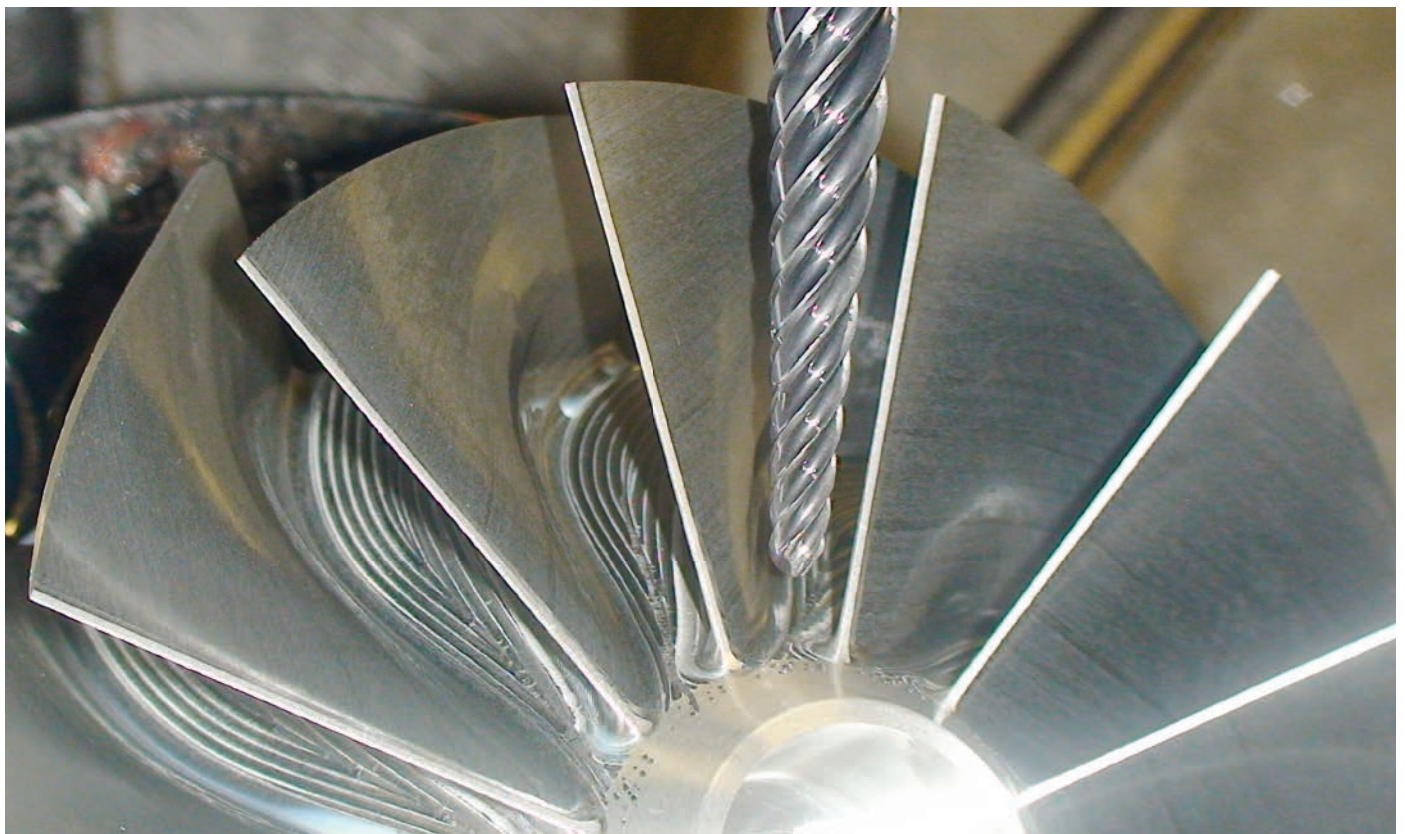

Konische Hartmetall-Kugelfräser
Tapered solid carbide ball nose end mills

N

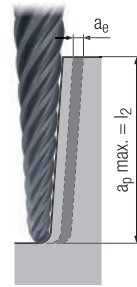

$a_e = 0,1 - 0,2 \text{ mm}$

Gültig für · Valid for
3548L

Für die Berechnung der Drehzahl n muss mit dem mittleren Durchmesser d_m (Messpunkt bei $0,5 \times a_p$) gerechnet werden.

For the calculation of rpm (n), use the average diameter d_m (measuring point at $0.5 \times a_p$).

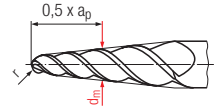

$$n = \frac{v_c \times 1000}{d_m \times \pi} \text{ [min}^{-1}\text{]}$$



	v_c [m/min]	f_z [mm]				
P	1.1	80	0,05		■	□
	2.1	70	0,04		■	□
	3.1	60	0,04		■	□
	4.1	60	0,03		■	
	5.1	50	0,03		■	
M	1.1	60	0,03			■
	2.1	60	0,03			■
	3.1	50	0,03			■
	4.1	50	0,03			■
K	1.1					
	1.2					
	2.1					
	2.2					
	3.1					
	3.2					
	4.1					
N	1.1					
	1.2					
	1.3	200	0,06			■
	1.4	140	0,06			■
	1.5	100	0,06			■
	1.6					
	2.1					
	2.2					
	2.3					
	2.4					
	2.5					
	2.6					
	2.7					
	2.8					
	3.1					
	3.2					
4.1						
4.2						
4.3						
4.4						
5.1						
5.2						
5.3						
S	1.1	60	0,03			■
	1.2	50	0,03			■
	1.3	30	0,03			■
	2.1					
	2.2	15	0,03			■
	2.3	15	0,03			■
	2.4	15	0,03			■
2.5	10	0,03			■	
2.6	15	0,03			■	
H	1.1					
	1.2					
	1.3					
	1.4					
	1.5					

v_c = Schnittgeschwindigkeit · Cutting speed
 f_z = Vorschub pro Zahn · Feed per tooth

■ = sehr gut geeignet · very suitable
□ = gut geeignet · suitable

- Hochleistungswerkzeug
- Mit 3 Schneiden im Radius
- 6 Umfangsschneiden

- High performance tool
- 3 flutes in the ball nose section
- 6 radial flutes

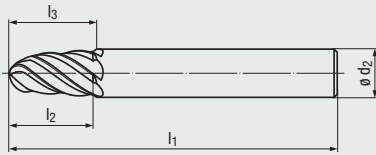
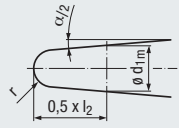

N

HM DIN 6535
HA
HB

38° **Kugel**

Optional



Allround

Beschichtung · Coating

TIALN

Einsatzgebiete – Material (siehe Seite 4)

- Speziell für hochfeste Werkstoffe geeignet
- Auch für Nickel-Basis-Legierungen einsetzbar
- Für die Zerspaltung von Titan-Legierungen geeignet
- Einsatz in allen Turbinenwerkstoffen möglich

Applications – material (see page 4)

- Especially suitable for high-strength materials
- Also suitable in nickel-base alloys
- For the machining of titanium alloys
- Suitable in all turbine materials

P 1.1-5.1

M 1.1-4.1

K 1.1-4.2

N 2.1-2.8

S 1.1-2.6

Bestell-Code · Order code

2679A

$\alpha/2$	r <small>±0,01</small>	l_2	l_3	l_1	d_{1m}	ϕd_2 h6	Z (Flutes)	Dimens.- Code			
4°	3	30	47	108	7,89	12	3/6	.04030A	●		
	3,5	39	39	108	9,26	12	3/6	.04035A	●		
	4	32	32	108	9,70	12	3/6	.04040A	●		
	5	35	49	108	11,77	16	3/6	.04050A	●		
	6	34	34	108	13,57	16	3/6	.04060A	●		
	8	36	36	108	17,44	20	3/6	.04080A	●		

Konische Hartmetall-Kugelfräser
Tapered solid carbide ball nose end mills

N

Vorschlichten
Pre-finishing

Schlichten
Finishing

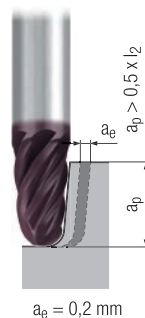
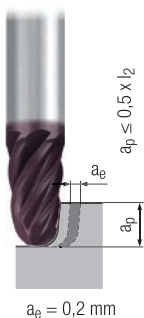
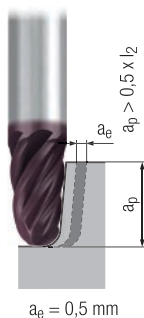
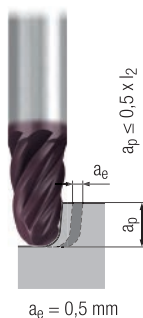

Gültig für · Valid for
2679A

Für die Berechnung der Drehzahl n muss mit dem mittleren Durchmesser d_m (Messpunkt bei $0,5 \times a_p$) gerechnet werden.

For the calculation of rpm (n), use the average diameter d_m (measuring point at $0,5 \times a_p$).

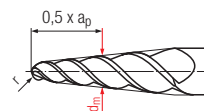

$$n = \frac{v_c \times 1000}{d_m \times \pi} \text{ [min}^{-1}\text{]}$$

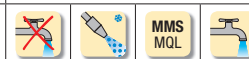

		Vorschlichten		Schlichten									
		v_c [m/min]	f_z [mm]	v_c [m/min]	f_z [mm]				v_c [m/min]	f_z [mm]			
P	1.1	130	0,008 x r	100	0,007 x r	160	0,011 x r	120	0,009 x r	<input type="checkbox"/>	<input checked="" type="checkbox"/>	<input type="checkbox"/>	<input checked="" type="checkbox"/>
	2.1	120	0,007 x r	90	0,006 x r	150	0,010 x r	110	0,008 x r	<input type="checkbox"/>	<input checked="" type="checkbox"/>	<input type="checkbox"/>	<input checked="" type="checkbox"/>
	3.1	110	0,006 x r	90	0,006 x r	140	0,009 x r	100	0,007 x r	<input type="checkbox"/>	<input checked="" type="checkbox"/>	<input type="checkbox"/>	<input type="checkbox"/>
	4.1	110	0,006 x r	80	0,005 x r	130	0,008 x r	100	0,006 x r	<input type="checkbox"/>	<input checked="" type="checkbox"/>	<input type="checkbox"/>	<input type="checkbox"/>
	5.1	100	0,005 x r	80	0,004 x r	120	0,007 x r	90	0,005 x r	<input type="checkbox"/>	<input checked="" type="checkbox"/>	<input type="checkbox"/>	<input type="checkbox"/>
M	1.1	70	0,006 x r	60	0,005 x r	90	0,008 x r	70	0,006 x r			<input type="checkbox"/>	<input checked="" type="checkbox"/>
	2.1	60	0,005 x r	50	0,004 x r	80	0,007 x r	60	0,005 x r			<input type="checkbox"/>	<input checked="" type="checkbox"/>
	3.1	50	0,004 x r	40	0,004 x r	60	0,006 x r	40	0,005 x r			<input type="checkbox"/>	<input checked="" type="checkbox"/>
	4.1	30	0,004 x r	30	0,003 x r	40	0,005 x r	30	0,004 x r			<input type="checkbox"/>	<input checked="" type="checkbox"/>
K	1.1	150	0,010 x r	120	0,008 x r	190	0,013 x r	140	0,011 x r	<input type="checkbox"/>	<input checked="" type="checkbox"/>	<input type="checkbox"/>	<input type="checkbox"/>
	1.2	150	0,010 x r	120	0,008 x r	190	0,013 x r	140	0,011 x r	<input type="checkbox"/>	<input checked="" type="checkbox"/>	<input type="checkbox"/>	<input type="checkbox"/>
	2.1	140	0,009 x r	110	0,008 x r	170	0,012 x r	130	0,010 x r	<input type="checkbox"/>	<input checked="" type="checkbox"/>	<input type="checkbox"/>	<input type="checkbox"/>
	2.2	140	0,009 x r	110	0,008 x r	170	0,012 x r	130	0,010 x r	<input type="checkbox"/>	<input checked="" type="checkbox"/>	<input type="checkbox"/>	<input type="checkbox"/>
	3.1	130	0,008 x r	100	0,007 x r	160	0,011 x r	120	0,009 x r	<input type="checkbox"/>	<input checked="" type="checkbox"/>	<input type="checkbox"/>	<input type="checkbox"/>
	3.2	130	0,008 x r	100	0,007 x r	160	0,011 x r	120	0,009 x r	<input type="checkbox"/>	<input checked="" type="checkbox"/>	<input type="checkbox"/>	<input type="checkbox"/>
	4.1	110	0,007 x r	90	0,006 x r	140	0,010 x r	100	0,008 x r	<input type="checkbox"/>	<input checked="" type="checkbox"/>	<input type="checkbox"/>	<input type="checkbox"/>
4.2	100	0,006 x r	80	0,006 x r	120	0,009 x r	90	0,007 x r	<input type="checkbox"/>	<input checked="" type="checkbox"/>	<input type="checkbox"/>	<input type="checkbox"/>	
N	1.1												
	1.2												
	1.3												
	1.4												
	1.5												
	1.6												
	2.1	160	0,008 x r	130	0,007 x r	200	0,011 x r	150	0,009 x r			<input type="checkbox"/>	<input checked="" type="checkbox"/>
	2.2	160	0,008 x r	130	0,007 x r	200	0,011 x r	150	0,009 x r			<input type="checkbox"/>	<input checked="" type="checkbox"/>
	2.3	160	0,008 x r	130	0,007 x r	200	0,011 x r	150	0,009 x r			<input type="checkbox"/>	<input checked="" type="checkbox"/>
	2.4	140	0,006 x r	110	0,006 x r	170	0,009 x r	130	0,007 x r			<input type="checkbox"/>	<input checked="" type="checkbox"/>
	2.5	140	0,006 x r	110	0,006 x r	170	0,009 x r	130	0,007 x r			<input type="checkbox"/>	<input checked="" type="checkbox"/>
	2.6	140	0,006 x r	110	0,006 x r	170	0,009 x r	130	0,007 x r			<input type="checkbox"/>	<input checked="" type="checkbox"/>
	2.7	90	0,006 x r	70	0,005 x r	110	0,008 x r	80	0,006 x r			<input type="checkbox"/>	<input checked="" type="checkbox"/>
	2.8	90	0,006 x r	70	0,005 x r	110	0,008 x r	80	0,006 x r			<input type="checkbox"/>	<input checked="" type="checkbox"/>
	3.1												
	3.2												
4.1													
4.2													
4.3													
4.4													
5.1													
5.2													
5.3													
S	1.1	100	0,008 x r	80	0,007 x r	120	0,011 x r	90	0,009 x r			<input type="checkbox"/>	<input checked="" type="checkbox"/>
	1.2	70	0,007 x r	60	0,006 x r	90	0,010 x r	70	0,008 x r			<input type="checkbox"/>	<input checked="" type="checkbox"/>
	1.3	50	0,006 x r	40	0,006 x r	60	0,009 x r	40	0,007 x r			<input type="checkbox"/>	<input checked="" type="checkbox"/>
	2.1	70	0,007 x r	50	0,006 x r	90	0,010 x r	60	0,008 x r			<input type="checkbox"/>	<input checked="" type="checkbox"/>
	2.2	30	0,006 x r	20	0,005 x r	40	0,008 x r	30	0,006 x r			<input type="checkbox"/>	<input checked="" type="checkbox"/>
	2.3	20	0,005 x r	20	0,004 x r	30	0,007 x r	20	0,005 x r			<input type="checkbox"/>	<input checked="" type="checkbox"/>
2.4	30	0,006 x r	20	0,005 x r	40	0,008 x r	30	0,006 x r			<input type="checkbox"/>	<input checked="" type="checkbox"/>	
2.5	20	0,005 x r	10	0,004 x r	20	0,007 x r	20	0,005 x r			<input type="checkbox"/>	<input checked="" type="checkbox"/>	
2.6	20	0,004 x r	20	0,004 x r	30	0,006 x r	20	0,005 x r			<input type="checkbox"/>	<input checked="" type="checkbox"/>	
H	1.1												
	1.2												
	1.3												
	1.4												
	1.5												

v_c = Schnittgeschwindigkeit · Cutting speed
 f_z = Vorschub pro Zahn · Feed per tooth

■ = sehr gut geeignet · very suitable
□ = gut geeignet · suitable

- Hochleistungswerkzeug
- Patentierte Querschneide
- Mit 4 Schneiden
- 2 Schneiden zur Mitte
- Kurze, stabile Schneidenlänge
- 2 Baulängen verfügbar

- High performance tool
- Patented chisel edge
- With 4 flutes
- 2 centre cutting edges
- Short, stable flute length
- 2 lengths available

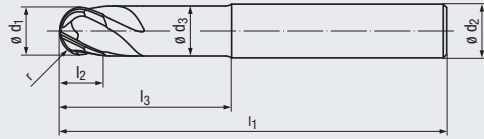

Design I₄:

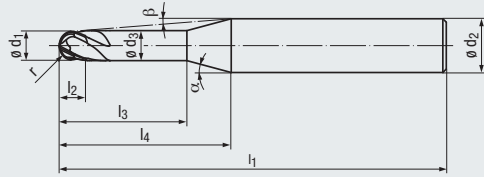

H

HM

DIN 6535
HA
HB

30°

Kugel

3-5°

Optional
≤ 66 HRC



Hard materials

Beschichtung · Coating

TIALN

Einsatzgebiete – Material (siehe Seite 4)

- Zur Bearbeitung harter Werkstoffe
- Zur Schlichtbearbeitung mit sehr guter Oberflächenqualität
- Zum HSC-Schlichten geeignet

Applications – material (see page 4)

- For machining hard materials
- For finishing with very high surface quality
- Suitable for HSC finishing

P	3.1-5.1	1.1-2.1
K	1.1-4.2	
N	2.3, 2.6-2.8	
N		2.2, 2.4-2.5
H	1.1-1.5	

Kurze Ausführung · Short design

Bestell-Code · Order code												2834A			
ϕd_1 ±0,01	r ±0,005	l_2	l_3	l_1	ϕd_3	l_4	ϕd_2 h5	α	β	Z (Flutes)	Dimens.- Code				
3	1,5	3,5	10	57	2,8	20	6	11,5°	5°	4	.003	●			
4	2	4	12	57	3,8	20	6	11°	3,5°	4	.004	●			
5	2,5	5	14	57	4,7	20	6	10°	2°	4	.005	●			
6	3	6	20	57	5,6	–	6	–	–	4	.006	●			
8	4	7	25	63	7,6	–	8	–	–	4	.008	●			
10	5	8	30	72	9,6	–	10	–	–	4	.010	●			
12	6	10	35	83	11,5	–	12	–	–	4	.012	●			



Werkzeug mit seitlicher Mitnahmefläche: Bestell-Code 2835A
Tool with side-lock clamping: order code 2835A



- 15-90° Alle Schneiden effektiv im Einsatz
All cutting edges in operation
- 0-15° 2 Schneiden effektiv im Einsatz
2 cutting edges in operation



Hartmetall-Kugelfräser – kurze Ausführung (4 Schneiden)
Solid carbide ball nose end mills – short design (4 flutes)

H

Gültig für · Valid for
2834A

Schruppen (4 Schneiden)
Roughing (4 flutes)

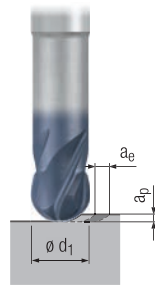

Schlichten (4 Schneiden)
Finishing (4 flutes)

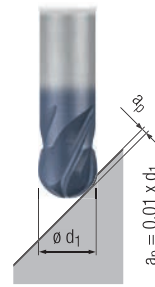

		V_c [m/min]	f_z [mm]	a_e [mm]	a_p [mm]	V_c [m/min]	f_z [mm]				
										MMS MQL	
P	1.1	280	$0,011 \times d_1$	$0,1 \times d_1$	$0,05 \times d_1$	360	$0,008 \times d_1$	<input type="checkbox"/>	<input checked="" type="checkbox"/>	<input type="checkbox"/>	<input checked="" type="checkbox"/>
	2.1	240	$0,011 \times d_1$	$0,1 \times d_1$	$0,05 \times d_1$	320	$0,008 \times d_1$	<input type="checkbox"/>	<input checked="" type="checkbox"/>	<input type="checkbox"/>	<input checked="" type="checkbox"/>
	3.1	210	$0,009 \times d_1$	$0,1 \times d_1$	$0,05 \times d_1$	270	$0,007 \times d_1$	<input type="checkbox"/>	<input checked="" type="checkbox"/>	<input type="checkbox"/>	<input type="checkbox"/>
	4.1	170	$0,008 \times d_1$	$0,1 \times d_1$	$0,05 \times d_1$	220	$0,006 \times d_1$	<input type="checkbox"/>	<input checked="" type="checkbox"/>	<input type="checkbox"/>	<input type="checkbox"/>
	5.1	140	$0,006 \times d_1$	$0,1 \times d_1$	$0,05 \times d_1$	180	$0,0054 \times d_1$	<input type="checkbox"/>	<input checked="" type="checkbox"/>	<input type="checkbox"/>	<input type="checkbox"/>
M	1.1										
	2.1										
	3.1										
	4.1										
K	1.1	280	$0,011 \times d_1$	$0,1 \times d_1$	$0,05 \times d_1$	360	$0,008 \times d_1$	<input type="checkbox"/>	<input checked="" type="checkbox"/>	<input type="checkbox"/>	<input type="checkbox"/>
	1.2	280	$0,011 \times d_1$	$0,1 \times d_1$	$0,05 \times d_1$	360	$0,008 \times d_1$	<input type="checkbox"/>	<input checked="" type="checkbox"/>	<input type="checkbox"/>	<input type="checkbox"/>
	2.1	250	$0,009 \times d_1$	$0,1 \times d_1$	$0,05 \times d_1$	320	$0,006 \times d_1$	<input type="checkbox"/>	<input checked="" type="checkbox"/>	<input type="checkbox"/>	<input type="checkbox"/>
	2.2	250	$0,009 \times d_1$	$0,1 \times d_1$	$0,05 \times d_1$	320	$0,006 \times d_1$	<input type="checkbox"/>	<input checked="" type="checkbox"/>	<input type="checkbox"/>	<input type="checkbox"/>
	3.1	210	$0,009 \times d_1$	$0,1 \times d_1$	$0,05 \times d_1$	270	$0,006 \times d_1$	<input type="checkbox"/>	<input checked="" type="checkbox"/>	<input type="checkbox"/>	<input type="checkbox"/>
	3.2	210	$0,009 \times d_1$	$0,1 \times d_1$	$0,05 \times d_1$	270	$0,006 \times d_1$	<input type="checkbox"/>	<input checked="" type="checkbox"/>	<input type="checkbox"/>	<input type="checkbox"/>
	4.1	170	$0,006 \times d_1$	$0,1 \times d_1$	$0,05 \times d_1$	220	$0,005 \times d_1$	<input type="checkbox"/>	<input checked="" type="checkbox"/>	<input type="checkbox"/>	<input type="checkbox"/>
	4.2	150	$0,006 \times d_1$	$0,1 \times d_1$	$0,05 \times d_1$	180	$0,005 \times d_1$	<input type="checkbox"/>	<input checked="" type="checkbox"/>	<input type="checkbox"/>	<input type="checkbox"/>
N	1.1										
	1.2										
	1.3										
	1.4										
	1.5										
	1.6										
	2.1										
	2.2	250	$0,011 \times d_1$	$0,1 \times d_1$	$0,05 \times d_1$	320	$0,008 \times d_1$			<input type="checkbox"/>	<input checked="" type="checkbox"/>
	2.3	250	$0,011 \times d_1$	$0,1 \times d_1$	$0,05 \times d_1$	320	$0,008 \times d_1$	<input type="checkbox"/>	<input type="checkbox"/>	<input type="checkbox"/>	<input checked="" type="checkbox"/>
	2.4	210	$0,009 \times d_1$	$0,1 \times d_1$	$0,05 \times d_1$	270	$0,007 \times d_1$			<input type="checkbox"/>	<input checked="" type="checkbox"/>
	2.5	210	$0,009 \times d_1$	$0,1 \times d_1$	$0,05 \times d_1$	270	$0,007 \times d_1$			<input type="checkbox"/>	<input checked="" type="checkbox"/>
	2.6	210	$0,009 \times d_1$	$0,1 \times d_1$	$0,05 \times d_1$	270	$0,007 \times d_1$	<input type="checkbox"/>	<input type="checkbox"/>	<input type="checkbox"/>	<input checked="" type="checkbox"/>
	2.7	130	$0,006 \times d_1$	$0,1 \times d_1$	$0,05 \times d_1$	170	$0,006 \times d_1$			<input type="checkbox"/>	<input checked="" type="checkbox"/>
	2.8	130	$0,006 \times d_1$	$0,1 \times d_1$	$0,05 \times d_1$	170	$0,005 \times d_1$			<input type="checkbox"/>	<input checked="" type="checkbox"/>
	3.1										
	3.2										
4.1											
4.2											
4.3											
4.4											
5.1											
5.2											
5.3											
S	1.1										
	1.2										
	1.3										
	2.1										
	2.2										
	2.3										
	2.4										
2.5											
2.6											
H	1.1	130	$0,008 \times d_1$	$0,05 \times d_1$	$0,02 \times d_1$	180	$0,006 \times d_1$	<input type="checkbox"/>	<input checked="" type="checkbox"/>	<input type="checkbox"/>	<input type="checkbox"/>
	1.2	120	$0,007 \times d_1$	$0,05 \times d_1$	$0,02 \times d_1$	160	$0,005 \times d_1$	<input type="checkbox"/>	<input checked="" type="checkbox"/>	<input type="checkbox"/>	<input type="checkbox"/>
	1.3					140	$0,005 \times d_1$	<input type="checkbox"/>	<input checked="" type="checkbox"/>	<input type="checkbox"/>	<input type="checkbox"/>
	1.4					110	$0,004 \times d_1$	<input type="checkbox"/>	<input checked="" type="checkbox"/>	<input type="checkbox"/>	<input type="checkbox"/>
	1.5					90	$0,003 \times d_1$	<input type="checkbox"/>	<input checked="" type="checkbox"/>	<input type="checkbox"/>	<input type="checkbox"/>

v_c = Schnittgeschwindigkeit · Cutting speed
 f_z = Vorschub pro Zahn · Feed per tooth

■ = sehr gut geeignet · very suitable
□ = gut geeignet · suitable

- Hochleistungswerkzeug
- Patentierte Querschneide
- Mit 4 Schneiden
- 4 Schneiden zur Mitte
- Kurze, stabile Schneidenlänge
- 2 Baulängen verfügbar

- High performance tool
- Patented chisel edge
- With 4 flutes
- 4 centre cutting edges
- Short, stable flute length
- 2 lengths available

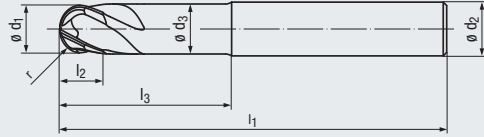

Design I₄:

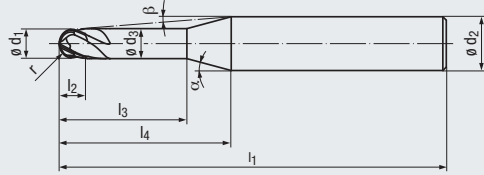

H

HM

DIN 6535
HA
HB

30°

Kugel

3-5°

Optional
≤ 66 HRC



Hard materials

Beschichtung · Coating

TIALN

Einsatzgebiete – Material (siehe Seite 4)

- Zur Bearbeitung harter Werkstoffe
- Zur Schlichtbearbeitung mit sehr guter Oberflächenqualität
- Zum HSC-Schlichten geeignet

Applications – material (see page 4)

- For machining hard materials
- For finishing with very high surface quality
- Suitable for HSC finishing

P	3.1-5.1	1.1-2.1
K	1.1-4.2	
N	2.3, 2.6-2.8	
N		2.2, 2.4-2.5
S	1.1-2.6	
H	1.1-1.5	

Lange Ausführung · Long design

Bestell-Code · Order code												2842A			
ϕd_1 ±0,01	r ±0,005	l_2	l_3	l_1	ϕd_3	l_4	ϕd_2 h5	α	β	Z (Flutes)	Dimens.- Code				
6	3	6	30	80	5,6	—	6	—	—	4	.006	●			
8	4	7	35	80	7,6	—	8	—	—	4	.008	●			
10	5	8	45	100	9,6	—	10	—	—	4	.010	●			
12	6	10	50	100	11,5	—	12	—	—	4	.012	●			



Werkzeug mit seitlicher Mitnahmeffläche: Bestell-Code 2843A
Tool with side-lock clamping: order code 2843A



Hartmetall-Kugelfräser – lange Ausführung (4 Schneiden)
Solid carbide ball nose end mills – long design (4 flutes)

H

Gültig für · Valid for
2842A

Schruppen (4 Schneiden)
Roughing (4 flutes)

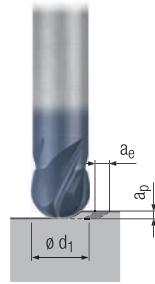

Schlichten (4 Schneiden)
Finishing (4 flutes)

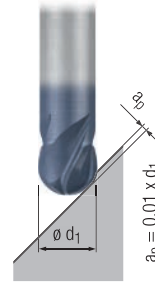

		V_c [m/min]	f_z [mm]	a_e [mm]	a_p [mm]	V_c [m/min]	f_z [mm]				
										MMS MQL	
P	1.1	280	$0,011 \times d_1$	$0,1 \times d_1$	$0,05 \times d_1$	360	$0,008 \times d_1$	<input type="checkbox"/>	<input checked="" type="checkbox"/>	<input type="checkbox"/>	<input checked="" type="checkbox"/>
	2.1	240	$0,011 \times d_1$	$0,1 \times d_1$	$0,05 \times d_1$	320	$0,008 \times d_1$	<input type="checkbox"/>	<input checked="" type="checkbox"/>	<input type="checkbox"/>	<input checked="" type="checkbox"/>
	3.1	210	$0,009 \times d_1$	$0,1 \times d_1$	$0,05 \times d_1$	270	$0,007 \times d_1$	<input type="checkbox"/>	<input checked="" type="checkbox"/>	<input type="checkbox"/>	<input type="checkbox"/>
	4.1	170	$0,008 \times d_1$	$0,1 \times d_1$	$0,05 \times d_1$	220	$0,006 \times d_1$	<input type="checkbox"/>	<input checked="" type="checkbox"/>	<input type="checkbox"/>	<input type="checkbox"/>
	5.1	140	$0,006 \times d_1$	$0,1 \times d_1$	$0,05 \times d_1$	180	$0,0054 \times d_1$	<input type="checkbox"/>	<input checked="" type="checkbox"/>	<input type="checkbox"/>	<input type="checkbox"/>
M	1.1										
	2.1										
	3.1										
	4.1										
K	1.1	280	$0,011 \times d_1$	$0,1 \times d_1$	$0,05 \times d_1$	360	$0,008 \times d_1$	<input type="checkbox"/>	<input checked="" type="checkbox"/>	<input type="checkbox"/>	<input type="checkbox"/>
	1.2	280	$0,011 \times d_1$	$0,1 \times d_1$	$0,05 \times d_1$	360	$0,008 \times d_1$	<input type="checkbox"/>	<input checked="" type="checkbox"/>	<input type="checkbox"/>	<input type="checkbox"/>
	2.1	250	$0,009 \times d_1$	$0,1 \times d_1$	$0,05 \times d_1$	320	$0,006 \times d_1$	<input type="checkbox"/>	<input checked="" type="checkbox"/>	<input type="checkbox"/>	<input type="checkbox"/>
	2.2	250	$0,009 \times d_1$	$0,1 \times d_1$	$0,05 \times d_1$	320	$0,006 \times d_1$	<input type="checkbox"/>	<input checked="" type="checkbox"/>	<input type="checkbox"/>	<input type="checkbox"/>
	3.1	210	$0,009 \times d_1$	$0,1 \times d_1$	$0,05 \times d_1$	270	$0,006 \times d_1$	<input type="checkbox"/>	<input checked="" type="checkbox"/>	<input type="checkbox"/>	<input type="checkbox"/>
	3.2	210	$0,009 \times d_1$	$0,1 \times d_1$	$0,05 \times d_1$	270	$0,006 \times d_1$	<input type="checkbox"/>	<input checked="" type="checkbox"/>	<input type="checkbox"/>	<input type="checkbox"/>
	4.1	170	$0,006 \times d_1$	$0,1 \times d_1$	$0,05 \times d_1$	220	$0,005 \times d_1$	<input type="checkbox"/>	<input checked="" type="checkbox"/>	<input type="checkbox"/>	<input type="checkbox"/>
	4.2	150	$0,006 \times d_1$	$0,1 \times d_1$	$0,05 \times d_1$	180	$0,005 \times d_1$	<input type="checkbox"/>	<input checked="" type="checkbox"/>	<input type="checkbox"/>	<input type="checkbox"/>
N	1.1										
	1.2										
	1.3										
	1.4										
	1.5										
	1.6										
	2.1										
	2.2	250	$0,011 \times d_1$	$0,1 \times d_1$	$0,05 \times d_1$	320	$0,008 \times d_1$			<input type="checkbox"/>	<input checked="" type="checkbox"/>
	2.3	250	$0,011 \times d_1$	$0,1 \times d_1$	$0,05 \times d_1$	320	$0,008 \times d_1$	<input type="checkbox"/>	<input type="checkbox"/>	<input type="checkbox"/>	<input checked="" type="checkbox"/>
	2.4	210	$0,009 \times d_1$	$0,1 \times d_1$	$0,05 \times d_1$	270	$0,007 \times d_1$			<input type="checkbox"/>	<input checked="" type="checkbox"/>
	2.5	210	$0,009 \times d_1$	$0,1 \times d_1$	$0,05 \times d_1$	270	$0,007 \times d_1$			<input type="checkbox"/>	<input checked="" type="checkbox"/>
	2.6	210	$0,009 \times d_1$	$0,1 \times d_1$	$0,05 \times d_1$	270	$0,007 \times d_1$	<input type="checkbox"/>	<input type="checkbox"/>	<input type="checkbox"/>	<input checked="" type="checkbox"/>
	2.7	130	$0,006 \times d_1$	$0,1 \times d_1$	$0,05 \times d_1$	170	$0,006 \times d_1$			<input type="checkbox"/>	<input checked="" type="checkbox"/>
	2.8	130	$0,006 \times d_1$	$0,1 \times d_1$	$0,05 \times d_1$	170	$0,005 \times d_1$			<input type="checkbox"/>	<input checked="" type="checkbox"/>
	3.1										
	3.2										
4.1											
4.2											
4.3											
4.4											
5.1											
5.2											
5.3											
S	1.1					150	$0,006 \times d_1$				<input checked="" type="checkbox"/>
	1.2					120	$0,005 \times d_1$				<input checked="" type="checkbox"/>
	1.3					70	$0,005 \times d_1$				<input checked="" type="checkbox"/>
	2.1					110	$0,006 \times d_1$				<input checked="" type="checkbox"/>
	2.2					50	$0,004 \times d_1$				<input checked="" type="checkbox"/>
	2.3					40	$0,004 \times d_1$				<input checked="" type="checkbox"/>
	2.4					40	$0,004 \times d_1$				<input checked="" type="checkbox"/>
2.5					30	$0,003 \times d_1$				<input checked="" type="checkbox"/>	
2.6					40	$0,003 \times d_1$				<input checked="" type="checkbox"/>	
H	1.1	130	$0,008 \times d_1$	$0,05 \times d_1$	$0,02 \times d_1$	180	$0,006 \times d_1$	<input type="checkbox"/>	<input checked="" type="checkbox"/>	<input type="checkbox"/>	<input type="checkbox"/>
	1.2	120	$0,007 \times d_1$	$0,05 \times d_1$	$0,02 \times d_1$	160	$0,005 \times d_1$	<input type="checkbox"/>	<input checked="" type="checkbox"/>	<input type="checkbox"/>	<input type="checkbox"/>
	1.3					140	$0,005 \times d_1$	<input type="checkbox"/>	<input checked="" type="checkbox"/>	<input type="checkbox"/>	<input type="checkbox"/>
	1.4					110	$0,004 \times d_1$	<input type="checkbox"/>	<input checked="" type="checkbox"/>	<input type="checkbox"/>	<input type="checkbox"/>
	1.5					90	$0,003 \times d_1$	<input type="checkbox"/>	<input checked="" type="checkbox"/>	<input type="checkbox"/>	<input type="checkbox"/>

v_c = Schnittgeschwindigkeit · Cutting speed
 f_z = Vorschub pro Zahn · Feed per tooth

= sehr gut geeignet · very suitable
 = gut geeignet · suitable

- Multifunktionales Hochleistungswerkzeug
- Mit 220-240° Kugelschneide
- 4 Schneiden zur Mitte
- 2 Baulängen verfügbar

- Multi-functional, high performance tool
- With 220-240° ball nose
- 4 centre cutting edges
- 2 lengths available

N

HM

DIN 6535
HA
HB

30° **220-240°**

Optional

≤ 55 HRC

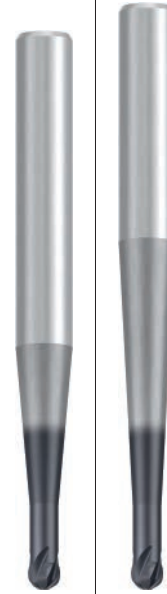

Allround

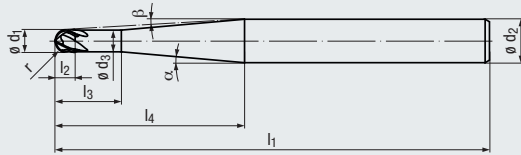

Beschichtung · Coating

ALCR

Einsatzgebiete – Material (siehe Seite 4)

Applications – material (see page 4)

- In vielen Werkstoffen einsetzbar
- Hinterschnittige Bearbeitung möglich
- Zum HSC-Schlichten von Turbinenschaufeln
- Speziell für schwer zerspanbare Werkstoffe geeignet

- For many materials
- Machining of undercuts
- Suitable for High-Speed finishing of turbine blades
- Especially suitable for difficult to cut materials

P	1.1-5.1
M	1.1-4.1
K	1.1-4.2
N	2.1-2.8
S	1.1-2.6
H	1.1-1.3

Lange Ausführung · Long design

Bestell-Code · Order code

2564L

$\varnothing d_1$	r	l_2	l_3	l_1	$\varnothing d_3$	l_4	$\varnothing d_2$	α	β	Z	Dimens.-Code
-0,04	-0,002						h_5			(Flutes)	
4	2	3,3	10	90	3	38,6	8	5°	3,5°	4	.04010B
6	3	4,6	15	100	5	43,6	10	5°	3°	4	.06015B
8	4	6,6	20	108	6	54,3	12	5°	2,5°	4	.08020B
10	5	8,3	25	125	7,5	73,6	16	5°	2°	4	.10025B

Extra lange Ausführung · Extra long design

Bestell-Code · Order code

2564L

$\varnothing d_1$	r	l_2	l_3	l_1	$\varnothing d_3$	l_4	$\varnothing d_2$	α	β	Z	Dimens.-Code
-0,04	-0,002						h_5			(Flutes)	
4	2	3,3	10	95	3	57,7	8	3°	2,5°	4	.04010A
6	3	4,6	15	105	5	62,7	10	3°	2°	4	.06015A
8	4	6,6	20	125	6	77,2	12	3°	2°	4	.08020A
10	5	8,3	25	160	7,5	106,1	16	3°	2°	4	.10025A



Kugel auf bis zu 240° schneidend einsetzbar
Ball nose with fully functional cutting edge up to 240°



Hartmetall-Kugelfräser „Lollipop“ – lange Ausführung (4 Schneiden)
Solid carbide ball nose end mills “Lollipop” – long design (4 flutes)

N

Schlichten (4 Schneiden)
Finishing (4 flutes)

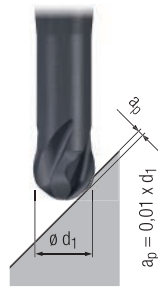

Gültig für · Valid for
2564L



	v_c [m/min]	f_z [mm]			MMS MQL	
P						
1.1	280	$0,008 \times d_1$	<input type="checkbox"/>	<input checked="" type="checkbox"/>	<input type="checkbox"/>	<input checked="" type="checkbox"/>
2.1	260	$0,008 \times d_1$	<input type="checkbox"/>	<input checked="" type="checkbox"/>	<input type="checkbox"/>	<input checked="" type="checkbox"/>
3.1	240	$0,007 \times d_1$	<input type="checkbox"/>	<input checked="" type="checkbox"/>	<input type="checkbox"/>	<input type="checkbox"/>
4.1	220	$0,006 \times d_1$	<input type="checkbox"/>	<input checked="" type="checkbox"/>	<input type="checkbox"/>	<input type="checkbox"/>
5.1	180	$0,0054 \times d_1$	<input type="checkbox"/>	<input checked="" type="checkbox"/>	<input type="checkbox"/>	<input type="checkbox"/>
M						
1.1	130	$0,006 \times d_1$			<input type="checkbox"/>	<input checked="" type="checkbox"/>
2.1	110	$0,006 \times d_1$			<input type="checkbox"/>	<input checked="" type="checkbox"/>
3.1	80	$0,005 \times d_1$			<input type="checkbox"/>	<input checked="" type="checkbox"/>
4.1	80	$0,005 \times d_1$			<input type="checkbox"/>	<input checked="" type="checkbox"/>
K						
1.1	280	$0,008 \times d_1$	<input type="checkbox"/>	<input checked="" type="checkbox"/>		<input type="checkbox"/>
1.2	260	$0,008 \times d_1$	<input type="checkbox"/>	<input checked="" type="checkbox"/>		<input type="checkbox"/>
2.1	240	$0,006 \times d_1$	<input type="checkbox"/>	<input checked="" type="checkbox"/>		<input type="checkbox"/>
2.2	220	$0,006 \times d_1$	<input type="checkbox"/>	<input checked="" type="checkbox"/>		<input type="checkbox"/>
3.1	200	$0,006 \times d_1$	<input type="checkbox"/>	<input checked="" type="checkbox"/>		<input type="checkbox"/>
3.2	200	$0,006 \times d_1$	<input type="checkbox"/>	<input checked="" type="checkbox"/>		<input type="checkbox"/>
4.1	180	$0,005 \times d_1$	<input type="checkbox"/>	<input checked="" type="checkbox"/>		<input type="checkbox"/>
4.2	150	$0,005 \times d_1$	<input type="checkbox"/>	<input checked="" type="checkbox"/>		<input type="checkbox"/>
N						
1.1						
1.2						
1.3						
1.4						
1.5						
1.6						
2.1	260	$0,008 \times d_1$			<input type="checkbox"/>	<input checked="" type="checkbox"/>
2.2	260	$0,008 \times d_1$			<input type="checkbox"/>	<input checked="" type="checkbox"/>
2.3	260	$0,008 \times d_1$	<input type="checkbox"/>	<input type="checkbox"/>	<input type="checkbox"/>	<input checked="" type="checkbox"/>
2.4	220	$0,007 \times d_1$			<input type="checkbox"/>	<input checked="" type="checkbox"/>
2.5	220	$0,007 \times d_1$			<input type="checkbox"/>	<input checked="" type="checkbox"/>
2.6	220	$0,007 \times d_1$	<input type="checkbox"/>	<input type="checkbox"/>	<input type="checkbox"/>	<input checked="" type="checkbox"/>
2.7	130	$0,006 \times d_1$			<input type="checkbox"/>	<input checked="" type="checkbox"/>
2.8	130	$0,005 \times d_1$			<input type="checkbox"/>	<input checked="" type="checkbox"/>
3.1						
3.2						
4.1						
4.2						
4.3						
4.4						
5.1						
5.2						
5.3						
S						
1.1	150	$0,006 \times d_1$				<input checked="" type="checkbox"/>
1.2	120	$0,005 \times d_1$				<input checked="" type="checkbox"/>
1.3	70	$0,005 \times d_1$				<input checked="" type="checkbox"/>
2.1	110	$0,006 \times d_1$				<input checked="" type="checkbox"/>
2.2	50	$0,004 \times d_1$				<input checked="" type="checkbox"/>
2.3	40	$0,004 \times d_1$				<input checked="" type="checkbox"/>
2.4	40	$0,004 \times d_1$				<input checked="" type="checkbox"/>
2.5	30	$0,003 \times d_1$				<input checked="" type="checkbox"/>
2.6	40	$0,003 \times d_1$				<input checked="" type="checkbox"/>
H						
1.1	160	$0,006 \times d_1$	<input type="checkbox"/>	<input checked="" type="checkbox"/>		
1.2	140	$0,005 \times d_1$	<input type="checkbox"/>	<input checked="" type="checkbox"/>		
1.3	120	$0,005 \times d_1$	<input type="checkbox"/>	<input checked="" type="checkbox"/>		
1.4						
1.5						

v_c = Schnittgeschwindigkeit · Cutting speed
 f_z = Vorschub pro Zahn · Feed per tooth

= sehr gut geeignet · very suitable
 = gut geeignet · suitable

- Hochleistungswerkzeug
- Mit 3 und 4 Schneiden
- Schruppverzahnung
- Ungleiche Teilung
- Vibrationsarme Bearbeitung
- Konuswinkel 3°

- High performance tool
- With 3 and 4 flutes
- Roughing profile
- Variable spacing
- Low-vibration machining
- Taper angle 3°

NR 

ICA

HM 

DIN 6535
HA
HB 

45° 

Torus 

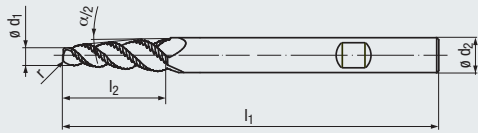

Design I₄:

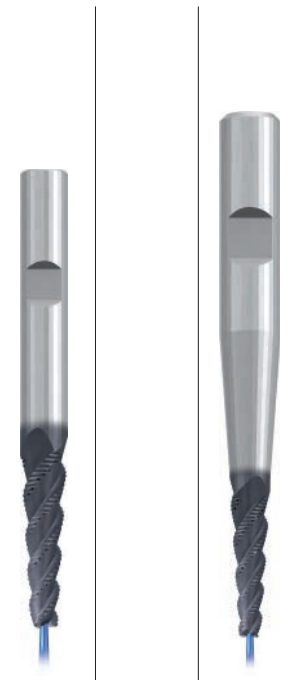
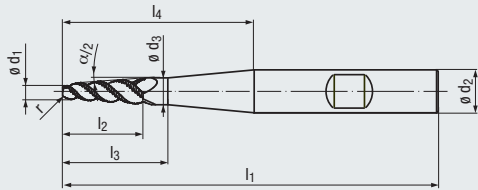

Allround

Allround

Beschichtung · Coating

ALCR

ALCR

Einsatzgebiete – Material (siehe Seite 4)

- Speziell für hochfeste Werkstoffe geeignet
- Auch für Nickel-Basis-Legierungen einsetzbar
- Für die Zerspanung von Titan-Legierungen geeignet
- Einsatz in allen Turbinenwerkstoffen möglich
- Optimiert zur Bearbeitung von Impellern und Integrated Bladed Rotors (IBR) aus Aluminium, Titan und Inconel

Applications – material (see page 4)

- Especially suitable for high-strength materials
- Also suitable in nickel-base alloys
- For the machining of titanium alloys
- Suitable in all turbine materials
- Optimised for machining Impellers and Integrated Bladed Rotors (IBR) made from aluminium, titanium and Inconel

P	1.1-5.1	P	1.1-5.1
M	1.1-4.1	M	1.1-4.1
N	1.1-1.3	N	1.1-1.3
S	1.1-1.3	S	1.1-1.3
S	2.2-2.6	S	2.2-2.6

Kurze Ausführung · Short design

Bestell-Code · Order code

3534LZ

$\alpha/2$	$\varnothing d_1$ -0,05	r	l_2	l_3	l_1	l_4	$\varnothing d_3$	$\varnothing d_2$ h6	Z (Flutes)	Dimens.- Code
3°	6,5	1	14	–	68	–	–	8	4	.03065A
	7,5	1	23,5	–	80	–	–	10	4	.03075A
	8,5	1	33	–	93	–	–	12	4	.03085A

Lange Ausführung · Long design

Bestell-Code · Order code

3532LZ

$\alpha/2$	$\varnothing d_1$ -0,05	r	l_2	l_3	l_1	l_4	$\varnothing d_3$	$\varnothing d_2$ h6	Z (Flutes)	Dimens.- Code
3°	5	1	20	29,5	80	38	7,1	8	3	.03050A
	5,5	1	25	34,5	95	52,5	8,1	10	3	.03055A
	6	1	30	39,5	120	67	9,1	12	3	.03060A



Konische Hartmetall-Torusfräser
Tapered solid carbide torus end mills

NR

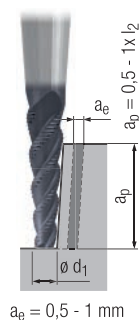
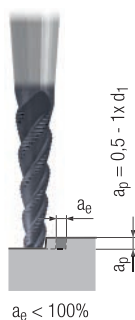

Gültig für · Valid for
3532LZ
3534LZ

Für die Berechnung der Drehzahl n muss mit dem mittleren Durchmesser d_m (Messpunkt bei $0,5 \times a_p$) gerechnet werden.

For the calculation of rpm (n), use the average diameter d_m (measuring point at $0,5 \times a_p$).

$$n = \frac{v_c \times 1000}{d_m \times \pi} \text{ [min}^{-1}\text{]}$$

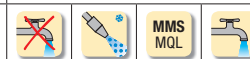

	V_c [m/min]	f_z [mm]	V_c [m/min]	f_z [mm]					
P	1.1	100	$0,005 \times d_1$	140	$0,005 \times d_1$		■	□	■
	2.1	90	$0,004 \times d_1$	130	$0,004 \times d_1$		■	□	■
	3.1	90	$0,004 \times d_1$	120	$0,004 \times d_1$		■	□	■
	4.1	80	$0,003 \times d_1$	110	$0,003 \times d_1$		■	□	■
	5.1	70	$0,003 \times d_1$	100	$0,003 \times d_1$		■	□	■
M	1.1	100	$0,004 \times d_1$	110	$0,004 \times d_1$				■
	2.1	80	$0,003 \times d_1$	90	$0,003 \times d_1$				■
	3.1	60	$0,002 \times d_1$	80	$0,002 \times d_1$				■
	4.1	50	$0,002 \times d_1$	60	$0,002 \times d_1$				■
K	1.1								
	1.2								
	2.1								
	2.2								
	3.1								
	3.2								
	4.1								
N	1.1	280	$0,006 \times d_1$	400	$0,006 \times d_1$				■
	1.2	200	$0,005 \times d_1$	280	$0,005 \times d_1$				■
	1.3	140	$0,004 \times d_1$	200	$0,004 \times d_1$				■
	1.4								
	1.5								
	1.6								
	2.1								
	2.2								
	2.3								
	2.4								
	2.5								
	2.6								
	2.7								
	2.8								
	3.1								
3.2									
4.1									
4.2									
4.3									
4.4									
5.1									
5.2									
5.3									
S	1.1	90	$0,002 \times d_1$	120	$0,002 \times d_1$				■
	1.2	75	$0,002 \times d_1$	100	$0,002 \times d_1$				■
	1.3	45	$0,002 \times d_1$	60	$0,002 \times d_1$				■
	2.1								
	2.2	25	$0,002 \times d_1$	30	$0,002 \times d_1$				■
	2.3	25	$0,002 \times d_1$	30	$0,002 \times d_1$				■
	2.4	25	$0,002 \times d_1$	30	$0,002 \times d_1$				■
	2.5	15	$0,002 \times d_1$	20	$0,002 \times d_1$				■
	2.6	25	$0,002 \times d_1$	30	$0,002 \times d_1$				■
H	1.1								
	1.2								
	1.3								
	1.4								
	1.5								

v_c = Schnittgeschwindigkeit · Cutting speed
 f_z = Vorschub pro Zahn · Feed per tooth

■ = sehr gut geeignet · very suitable
□ = gut geeignet · suitable

- Multifunktionales Werkzeug
- Mit 2 Schneiden
- Verschiedene Kegelwinkel
- Auch mit poliertem Spanraum erhältlich
- Multi-functional tool
- With 2 flutes
- Various taper angles
- Also available with polished chip space

N

HM

DIN 6535

HA
HB

30°

Torus

Optional

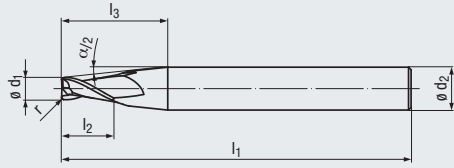

Design I₄:

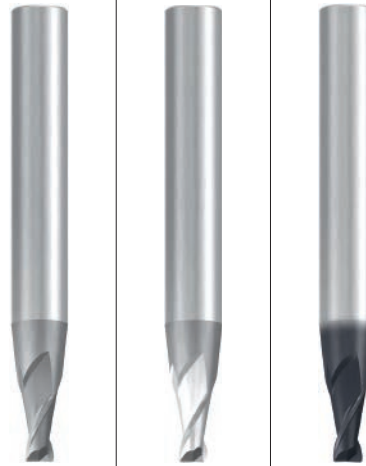
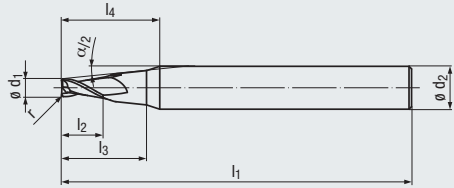

Mit poliertem Spanraum
With polished chip space

Allround

Allround

Beschichtung · Coating

Einsatzgebiete – Material (siehe Seite 4)

- In fast allen Werkstoffen einsetzbar
- Zum Schruppen geeignet

Applications – material (see page 4)

- For almost all materials
- Suitable for roughing

ALCR

N 1.1-1.3
N 4.1-4.2

P 1.1-3.1 4.1-5.1
M 1.1-2.1
K 1.1-2.2 3.1-4.2
N 1.1-1.4 1.5
N 2.1-2.6 2.7-2.8
N 3.1-4.4, 5.2-5.3
S 1.1-1.2 1.3
S 2.1-2.2 2.3-2.6

Bestell-Code · Order code

$\alpha/2$	$\varnothing d_1$	r $\pm 0,01$	l_2	l_3	l_1	l_4	$\varnothing d_2$ h6	Z (Flutes)	Dimens.- Code	3444	3445	3444L
3°	3	0,3	6	24	63	26	8	2	.03003A	●	●	●
	4	0,4	8	24	63	26	8	2	.03004A	●	●	●
	5	0,5	10	25	63	26	8	2	.03005A	●	●	●
4°	3	0,3	6	24	63	26	8	2	.04003A	●	●	●
	4	0,4	8	25	63	26	8	2	.04004A	●	●	●
	5	0,5	10	23	63	—	8	2	.04005A	●	●	●
6°	3	0,3	6	25	63	—	8	2	.06003A	●	●	●
	4	0,4	8	20	63	—	8	2	.06004A	●	●	●
	5	0,5	10	25	80	—	10	2	.06005A	●	●	●
8°	3	0,3	6	25	80	—	10	2	.08003A	●	●	●
	4	0,4	8	22	80	—	10	2	.08004A	●	●	●
	5	0,5	10	25	83	—	12	2	.08005A	●	●	●

Konische Hartmetall-Torusfräser
Tapered solid carbide torus end mills

N

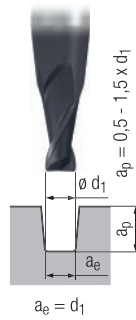
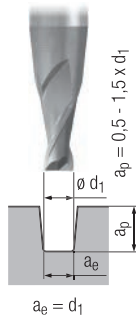

Gültig für · Valid for
3444 3444L 3445

Für die Berechnung der Drehzahl n muss mit dem mittleren Durchmesser d_m (Messpunkt bei $0,5 \times a_p$) gerechnet werden.

For the calculation of rpm (n), use the average diameter d_m (measuring point at $0,5 \times a_p$).

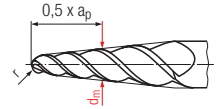

$$n = \frac{v_c \times 1000}{d_m \times \pi} \text{ [min}^{-1}\text{]}$$

Unbeschichtet · Uncoated

ALCR



	Unbeschichtet · Uncoated				ALCR								
	v_c [m/min]	f_z [mm]	v_c [m/min]	f_z [mm]	v_c [m/min]	f_z [mm]	v_c [m/min]	f_z [mm]					
P	1.1						220	$0,010 \times d_1$	☐	■	☐	■	
	2.1						200	$0,009 \times d_1$	☐	■	☐	■	
	3.1						160	$0,008 \times d_1$	☐	■	☐	■	
	4.1						130	$0,007 \times d_1$	☐	■	☐	■	
	5.1						110	$0,006 \times d_1$	☐	■	☐	■	
M	1.1						110	$0,006 \times d_1$			☐	■	
	2.1						90	$0,006 \times d_1$			☐	■	
	3.1										☐	■	
	4.1										☐	■	
K	1.1						220	$0,010 \times d_1$	■	■			
	1.2						220	$0,010 \times d_1$	■	■			
	2.1						190	$0,008 \times d_1$	■	■			
	2.2						190	$0,008 \times d_1$	■	■			
	3.1						160	$0,008 \times d_1$	■	■			
	3.2						160	$0,008 \times d_1$	■	■			
	4.1						130	$0,006 \times d_1$	■	■			
	4.2						110	$0,006 \times d_1$	■	■			
N	1.1	280	$0,010 \times d_1$	350	$0,016 \times d_1$	400	$0,010 \times d_1$	500	$0,016 \times d_1$			☐	■
	1.2	280	$0,008 \times d_1$	350	$0,014 \times d_1$	400	$0,008 \times d_1$	500	$0,014 \times d_1$			☐	■
	1.3	250	$0,006 \times d_1$	350	$0,012 \times d_1$	350	$0,006 \times d_1$	500	$0,012 \times d_1$			☐	■
	1.4							380	$0,014 \times d_1$			☐	■
	1.5							340	$0,012 \times d_1$			☐	■
	1.6											☐	■
	2.1							200	$0,010 \times d_1$			☐	■
	2.2							200	$0,010 \times d_1$			☐	■
	2.3							200	$0,010 \times d_1$	☐	☐	☐	■
	2.4							160	$0,008 \times d_1$			☐	■
	2.5							160	$0,008 \times d_1$			☐	■
	2.6							160	$0,008 \times d_1$	☐	☐	☐	■
	2.7							100	$0,006 \times d_1$			☐	■
	2.8							100	$0,006 \times d_1$			☐	■
	3.1							450	$0,018 \times d_1$			☐	■
	3.2							450	$0,014 \times d_1$			☐	■
4.1			220	$0,015 \times d_1$			320	$0,015 \times d_1$			☐	■	
4.2			350	$0,015 \times d_1$			500	$0,015 \times d_1$			☐	■	
4.3							200	$0,012 \times d_1$			☐	■	
4.4							140	$0,012 \times d_1$			☐	■	
5.1											☐	■	
5.2							120	$0,006 \times d_1$			☐	■	
5.3							220	$0,012 \times d_1$	☐	■		■	
S	1.1					50	$0,004 \times d_1$	110	$0,007 \times d_1$			☐	■
	1.2					40	$0,003 \times d_1$	90	$0,006 \times d_1$			☐	■
	1.3					30	$0,003 \times d_1$	50	$0,005 \times d_1$			☐	■
	2.1							80	$0,006 \times d_1$			☐	■
	2.2							30	$0,004 \times d_1$			☐	■
	2.3							30	$0,004 \times d_1$			☐	■
2.4							30	$0,004 \times d_1$			☐	■	
2.5							20	$0,004 \times d_1$			☐	■	
2.6							30	$0,004 \times d_1$			☐	■	
H	1.1												
	1.2												
	1.3												
	1.4												
	1.5												

v_c = Schnittgeschwindigkeit · Cutting speed
 f_z = Vorschub pro Zahn · Feed per tooth

■ = sehr gut geeignet · very suitable
☐ = gut geeignet · suitable

- Hochleistungswerkzeug
- Mit 5-13 Schneiden
- Ungleiche Teilung
- Vibrationsarme Bearbeitung
- Innere Kühlschmierstoff-Zufuhr, Austritt axial (ICA)

- High performance tool
- With 5-13 flutes
- Variable spacing
- Low-vibration machining
- Internal coolant supply, axial exit (ICA)

N

ICA



HM



Torus



Optional



Allround



Allround

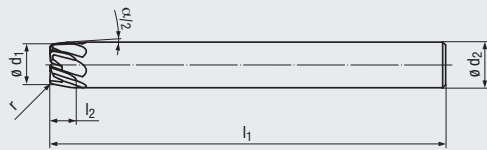

Beschichtung · Coating

TIALN

TIALN

Einsatzgebiete – Material (siehe Seite 4)

- Speziell für hochfeste Werkstoffe geeignet
- Auch für Nickel-Basis-Legierungen einsetzbar
- Für die Zerspanung von Titan-Legierungen geeignet
- Einsatz in allen Turbinenwerkstoffen möglich

Applications – material (see page 4)

- Especially suitable for high-strength materials
- Also suitable in nickel-base alloys
- For the machining of titanium alloys
- Suitable in all turbine materials

P	1.1-5.1	P	1.1-5.1
M	1.1-4.1	M	1.1-4.1
K	1.1-4.2	K	1.1-4.2
N	2.1-2.8	N	2.1-2.8
S	1.1-2.6	S	1.1-2.6

Lange Ausführung · Long design

Bestell-Code · Order code								2677AZ			
$\alpha/2$	$\varnothing d_1$	r $\pm 0,01$	l_2	l_1	$\varnothing d_2$ h6	Z (Flutes)	Dimens.- Code				
8°	8	0,8	7,5	80	10	7	.008008	●			
	9	1	3,5	80	10	7	.009010	●			
	10	1	7,5	80	12	9	.010010	●			
	11	1	3,5	80	12	9	.011010	●			

Extra lange Ausführung · Extra long design

Bestell-Code · Order code										2678AZ	
$\alpha/2$	$\varnothing d_1$	r $\pm 0,01$	l_2	l_1	$\varnothing d_2$ h6	Z (Flutes)	Dimens.- Code				
8°	9	1	3,5	108	10	5	.009010			●	
	10	1	7,5	108	12	7	.010010			●	
	11	1	3,5	108	12	7	.011010			●	
	15	1	3,5	108	16	9	.015010			●	
	15	1	3,5	108	16	13	.115010			●	
	19	1	3,5	108	20	9	.019010			●	
	19	1	3,5	108	20	13	.119010			●	

Konische Hartmetall-Torusfräser – lange und extra lange Ausführung
Tapered solid carbide torus end mills – long and extra long design

Gültig für · Valid for
2677AZ 2678AZ



N

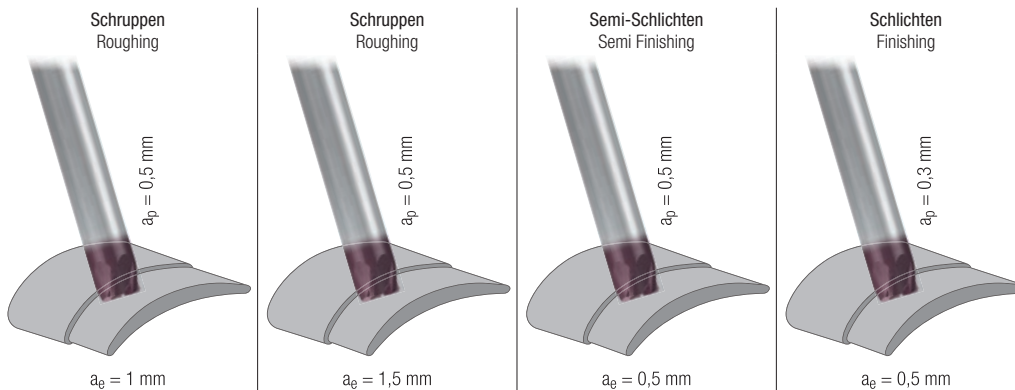

	V _C [m/min]	f _Z [mm]	V _C [m/min]	f _Z [mm]	V _C [m/min]	f _Z [mm]	V _C [m/min]	f _Z [mm]					
											MMS MQL		
P	1.1	160	0,005 x d ₁	140	0,004 x d ₁	180	0,008 x d ₁	200	0,006 x d ₁	<input type="checkbox"/>	<input checked="" type="checkbox"/>	<input type="checkbox"/>	<input checked="" type="checkbox"/>
	2.1	150	0,005 x d ₁	130	0,004 x d ₁	170	0,007 x d ₁	190	0,005 x d ₁	<input type="checkbox"/>	<input checked="" type="checkbox"/>	<input type="checkbox"/>	<input checked="" type="checkbox"/>
	3.1	140	0,004 x d ₁	120	0,003 x d ₁	160	0,006 x d ₁	180	0,005 x d ₁	<input type="checkbox"/>	<input checked="" type="checkbox"/>	<input type="checkbox"/>	<input type="checkbox"/>
	4.1	130	0,004 x d ₁	110	0,003 x d ₁	150	0,006 x d ₁	170	0,004 x d ₁	<input type="checkbox"/>	<input checked="" type="checkbox"/>	<input type="checkbox"/>	<input type="checkbox"/>
	5.1	120	0,003 x d ₁	110	0,002 x d ₁	140	0,005 x d ₁	160	0,004 x d ₁	<input type="checkbox"/>	<input checked="" type="checkbox"/>	<input type="checkbox"/>	<input type="checkbox"/>
M	1.1	90	0,004 x d ₁	80	0,003 x d ₁	100	0,006 x d ₁	120	0,004 x d ₁			<input type="checkbox"/>	<input checked="" type="checkbox"/>
	2.1	80	0,003 x d ₁	70	0,002 x d ₁	90	0,005 x d ₁	100	0,004 x d ₁			<input type="checkbox"/>	<input checked="" type="checkbox"/>
	3.1	60	0,003 x d ₁	50	0,002 x d ₁	70	0,004 x d ₁	80	0,003 x d ₁			<input type="checkbox"/>	<input checked="" type="checkbox"/>
	4.1	40	0,002 x d ₁	40	0,002 x d ₁	50	0,004 x d ₁	60	0,003 x d ₁			<input type="checkbox"/>	<input checked="" type="checkbox"/>
K	1.1	190	0,006 x d ₁	160	0,005 x d ₁	210	0,01 x d ₁	240	0,007 x d ₁	<input type="checkbox"/>	<input checked="" type="checkbox"/>	<input type="checkbox"/>	<input type="checkbox"/>
	1.2	190	0,006 x d ₁	160	0,005 x d ₁	210	0,01 x d ₁	240	0,007 x d ₁	<input type="checkbox"/>	<input checked="" type="checkbox"/>	<input type="checkbox"/>	<input type="checkbox"/>
	2.1	170	0,006 x d ₁	150	0,004 x d ₁	190	0,009 x d ₁	220	0,007 x d ₁	<input type="checkbox"/>	<input checked="" type="checkbox"/>	<input type="checkbox"/>	<input type="checkbox"/>
	2.2	170	0,006 x d ₁	150	0,004 x d ₁	190	0,009 x d ₁	220	0,007 x d ₁	<input type="checkbox"/>	<input checked="" type="checkbox"/>	<input type="checkbox"/>	<input type="checkbox"/>
	3.1	160	0,005 x d ₁	140	0,004 x d ₁	180	0,008 x d ₁	200	0,006 x d ₁	<input type="checkbox"/>	<input checked="" type="checkbox"/>	<input type="checkbox"/>	<input type="checkbox"/>
	3.2	160	0,005 x d ₁	140	0,004 x d ₁	180	0,008 x d ₁	200	0,006 x d ₁	<input type="checkbox"/>	<input checked="" type="checkbox"/>	<input type="checkbox"/>	<input type="checkbox"/>
	4.1	140	0,005 x d ₁	120	0,004 x d ₁	160	0,007 x d ₁	180	0,005 x d ₁	<input type="checkbox"/>	<input checked="" type="checkbox"/>	<input type="checkbox"/>	<input type="checkbox"/>
	4.2	120	0,004 x d ₁	110	0,003 x d ₁	140	0,006 x d ₁	160	0,005 x d ₁	<input type="checkbox"/>	<input checked="" type="checkbox"/>	<input type="checkbox"/>	<input type="checkbox"/>
N	1.1												
	1.2												
	1.3												
	1.4												
	1.5												
	1.6												
	2.1	200	0,005 x d ₁	180	0,004 x d ₁	230	0,008 x d ₁	260	0,006 x d ₁			<input type="checkbox"/>	<input checked="" type="checkbox"/>
	2.2	200	0,005 x d ₁	180	0,004 x d ₁	230	0,008 x d ₁	260	0,006 x d ₁			<input type="checkbox"/>	<input checked="" type="checkbox"/>
	2.3	200	0,005 x d ₁	180	0,004 x d ₁	230	0,008 x d ₁	260	0,006 x d ₁			<input type="checkbox"/>	<input checked="" type="checkbox"/>
	2.4	170	0,004 x d ₁	150	0,003 x d ₁	190	0,006 x d ₁	220	0,005 x d ₁			<input type="checkbox"/>	<input checked="" type="checkbox"/>
	2.5	170	0,004 x d ₁	150	0,003 x d ₁	190	0,006 x d ₁	220	0,005 x d ₁			<input type="checkbox"/>	<input checked="" type="checkbox"/>
	2.6	170	0,004 x d ₁	150	0,003 x d ₁	190	0,006 x d ₁	220	0,005 x d ₁			<input type="checkbox"/>	<input checked="" type="checkbox"/>
	2.7	110	0,004 x d ₁	90	0,003 x d ₁	120	0,006 x d ₁	140	0,004 x d ₁			<input type="checkbox"/>	<input checked="" type="checkbox"/>
	2.8	110	0,004 x d ₁	90	0,003 x d ₁	120	0,006 x d ₁	140	0,004 x d ₁			<input type="checkbox"/>	<input checked="" type="checkbox"/>
	3.1												
	3.2												
4.1													
4.2													
4.3													
4.4													
5.1													
5.2													
5.3													
S	1.1	120	0,005 x d ₁	110	0,004 x d ₁	140	0,008 x d ₁	160	0,006 x d ₁			<input type="checkbox"/>	<input checked="" type="checkbox"/>
	1.2	90	0,005 x d ₁	80	0,004 x d ₁	100	0,007 x d ₁	120	0,005 x d ₁			<input type="checkbox"/>	<input checked="" type="checkbox"/>
	1.3	60	0,004 x d ₁	50	0,003 x d ₁	70	0,006 x d ₁	80	0,005 x d ₁			<input type="checkbox"/>	<input checked="" type="checkbox"/>
	2.1	90	0,005 x d ₁	80	0,004 x d ₁	100	0,007 x d ₁	110	0,005 x d ₁			<input type="checkbox"/>	<input checked="" type="checkbox"/>
	2.2	40	0,004 x d ₁	30	0,003 x d ₁	50	0,006 x d ₁	50	0,004 x d ₁			<input type="checkbox"/>	<input checked="" type="checkbox"/>
	2.3	30	0,003 x d ₁	30	0,002 x d ₁	30	0,005 x d ₁	40	0,004 x d ₁			<input type="checkbox"/>	<input checked="" type="checkbox"/>
	2.4	40	0,004 x d ₁	30	0,003 x d ₁	50	0,006 x d ₁	50	0,004 x d ₁			<input type="checkbox"/>	<input checked="" type="checkbox"/>
2.5	20	0,003 x d ₁	20	0,002 x d ₁	30	0,005 x d ₁	30	0,004 x d ₁			<input type="checkbox"/>	<input checked="" type="checkbox"/>	
2.6	30	0,003 x d ₁	30	0,002 x d ₁	30	0,004 x d ₁	40	0,003 x d ₁			<input type="checkbox"/>	<input checked="" type="checkbox"/>	
H	1.1												
	1.2												
	1.3												
	1.4												
	1.5												

v_C = Schnittgeschwindigkeit · Cutting speed
f_Z = Vorschub pro Zahn · Feed per tooth

■ = sehr gut geeignet · very suitable
□ = gut geeignet · suitable

- Hochleistungswerkzeug
- Mit 5-9 Schneiden
- Ungleiche Teilung
- Vibrationsarme Bearbeitung
- Innere Kühlschmierstoff-Zufuhr, Austritt axial (ICA)

- High performance tool
- With 5-9 flutes
- Variable spacing
- Low-vibration machining
- Internal coolant supply, axial exit (ICA)

N

ICA

HM

DIN 6535
HA
HB



Optional



Allround

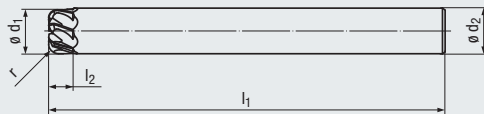

Beschichtung · Coating

TIALN

Einsatzgebiete – Material (siehe Seite 4)

- Speziell für hochfeste Werkstoffe geeignet
- Auch für Nickel-Basis-Legierungen einsetzbar
- Für die Zerspanung von Titan-Legierungen geeignet
- Einsatz in allen Turbinenwerkstoffen möglich

Applications – material (see page 4)

- Especially suitable for high-strength materials
- Also suitable in nickel-base alloys
- For the machining of titanium alloys
- Suitable in all turbine materials

- P** 1.1-5.1
- M** 1.1-4.1
- K** 1.1-4.2
- N** 2.1-2.8
- S** 1.1-2.6

Bestell-Code · Order code

2676AZ

ϕd_1	r	l_2	l_1	ϕd_2	Z (Flutes)	Dimens.- Code			
8	1	3	80	8	5	.008010	●		
8	2	4	80	8	5	.008020	●		
10	1	3	80	10	7	.010010	●		
10	2	4	80	10	7	.010020	●		
12	1	3	108	12	7	.012010	●		
12	2	4	108	12	7	.012020	●		
16	1	3	108	16	9	.016010	●		
16	2	4	108	16	9	.016020	●		

Hartmetall-Torusfräser
Solid carbide torus end mills

N

Gültig für · Valid for
2676AZ

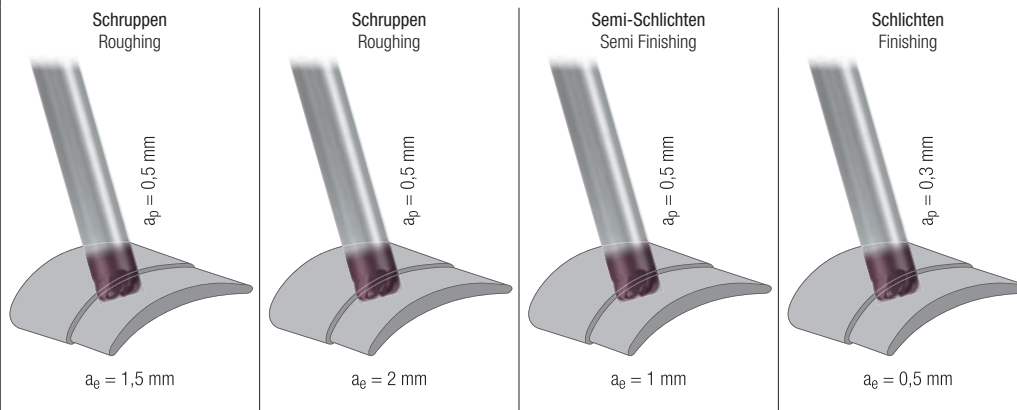

		Schruppen Roughing		Schruppen Roughing		Semi-Schlichten Semi Finishing		Schlichten Finishing					
		V_c [m/min]	f_z [mm]	V_c [m/min]	f_z [mm]	V_c [m/min]	f_z [mm]	V_c [m/min]	f_z [mm]				
P	1.1	160	$0,008 \times d_1$	140	$0,007 \times d_1$	180	$0,009 \times d_1$	200	$0,006 \times d_1$	<input type="checkbox"/>	<input checked="" type="checkbox"/>	<input type="checkbox"/>	<input checked="" type="checkbox"/>
	2.1	150	$0,007 \times d_1$	130	$0,006 \times d_1$	170	$0,008 \times d_1$	190	$0,005 \times d_1$	<input type="checkbox"/>	<input checked="" type="checkbox"/>	<input type="checkbox"/>	<input checked="" type="checkbox"/>
	3.1	140	$0,006 \times d_1$	120	$0,006 \times d_1$	160	$0,007 \times d_1$	180	$0,005 \times d_1$	<input type="checkbox"/>	<input checked="" type="checkbox"/>	<input type="checkbox"/>	<input type="checkbox"/>
	4.1	130	$0,006 \times d_1$	110	$0,005 \times d_1$	150	$0,006 \times d_1$	170	$0,004 \times d_1$	<input type="checkbox"/>	<input checked="" type="checkbox"/>	<input type="checkbox"/>	<input type="checkbox"/>
	5.1	120	$0,005 \times d_1$	110	$0,004 \times d_1$	140	$0,005 \times d_1$	160	$0,004 \times d_1$	<input type="checkbox"/>	<input checked="" type="checkbox"/>	<input type="checkbox"/>	<input type="checkbox"/>
M	1.1	90	$0,006 \times d_1$	80	$0,005 \times d_1$	100	$0,006 \times d_1$	120	$0,004 \times d_1$			<input type="checkbox"/>	<input checked="" type="checkbox"/>
	2.1	80	$0,005 \times d_1$	70	$0,004 \times d_1$	90	$0,005 \times d_1$	100	$0,004 \times d_1$			<input type="checkbox"/>	<input checked="" type="checkbox"/>
	3.1	60	$0,004 \times d_1$	50	$0,004 \times d_1$	70	$0,005 \times d_1$	80	$0,003 \times d_1$			<input type="checkbox"/>	<input checked="" type="checkbox"/>
	4.1	40	$0,004 \times d_1$	40	$0,003 \times d_1$	50	$0,004 \times d_1$	60	$0,003 \times d_1$			<input type="checkbox"/>	<input checked="" type="checkbox"/>
K	1.1	190	$0,01 \times d_1$	160	$0,008 \times d_1$	210	$0,011 \times d_1$	240	$0,007 \times d_1$	<input type="checkbox"/>	<input checked="" type="checkbox"/>	<input type="checkbox"/>	<input type="checkbox"/>
	1.2	190	$0,01 \times d_1$	160	$0,008 \times d_1$	210	$0,011 \times d_1$	240	$0,007 \times d_1$	<input type="checkbox"/>	<input checked="" type="checkbox"/>	<input type="checkbox"/>	<input type="checkbox"/>
	2.1	170	$0,009 \times d_1$	150	$0,008 \times d_1$	190	$0,01 \times d_1$	220	$0,007 \times d_1$	<input type="checkbox"/>	<input checked="" type="checkbox"/>	<input type="checkbox"/>	<input type="checkbox"/>
	2.2	170	$0,009 \times d_1$	150	$0,008 \times d_1$	190	$0,01 \times d_1$	220	$0,007 \times d_1$	<input type="checkbox"/>	<input checked="" type="checkbox"/>	<input type="checkbox"/>	<input type="checkbox"/>
	3.1	160	$0,008 \times d_1$	140	$0,007 \times d_1$	180	$0,009 \times d_1$	200	$0,006 \times d_1$	<input type="checkbox"/>	<input checked="" type="checkbox"/>	<input type="checkbox"/>	<input type="checkbox"/>
	3.2	160	$0,008 \times d_1$	140	$0,007 \times d_1$	180	$0,009 \times d_1$	200	$0,006 \times d_1$	<input type="checkbox"/>	<input checked="" type="checkbox"/>	<input type="checkbox"/>	<input type="checkbox"/>
	4.1	140	$0,007 \times d_1$	120	$0,006 \times d_1$	160	$0,008 \times d_1$	180	$0,005 \times d_1$	<input type="checkbox"/>	<input checked="" type="checkbox"/>	<input type="checkbox"/>	<input type="checkbox"/>
	4.2	120	$0,006 \times d_1$	110	$0,006 \times d_1$	140	$0,007 \times d_1$	160	$0,005 \times d_1$	<input type="checkbox"/>	<input checked="" type="checkbox"/>	<input type="checkbox"/>	<input type="checkbox"/>
N	1.1												
	1.2												
	1.3												
	1.4												
	1.5												
	1.6												
	2.1	200	$0,008 \times d_1$	180	$0,007 \times d_1$	230	$0,009 \times d_1$	260	$0,006 \times d_1$			<input type="checkbox"/>	<input checked="" type="checkbox"/>
	2.2	200	$0,008 \times d_1$	180	$0,007 \times d_1$	230	$0,009 \times d_1$	260	$0,006 \times d_1$			<input type="checkbox"/>	<input checked="" type="checkbox"/>
	2.3	200	$0,008 \times d_1$	180	$0,007 \times d_1$	230	$0,009 \times d_1$	260	$0,006 \times d_1$			<input type="checkbox"/>	<input checked="" type="checkbox"/>
	2.4	170	$0,006 \times d_1$	150	$0,006 \times d_1$	190	$0,007 \times d_1$	220	$0,005 \times d_1$			<input type="checkbox"/>	<input checked="" type="checkbox"/>
	2.5	170	$0,006 \times d_1$	150	$0,006 \times d_1$	190	$0,007 \times d_1$	220	$0,005 \times d_1$			<input type="checkbox"/>	<input checked="" type="checkbox"/>
	2.6	170	$0,006 \times d_1$	150	$0,006 \times d_1$	190	$0,007 \times d_1$	220	$0,005 \times d_1$			<input type="checkbox"/>	<input checked="" type="checkbox"/>
	2.7	110	$0,006 \times d_1$	90	$0,005 \times d_1$	120	$0,006 \times d_1$	140	$0,004 \times d_1$			<input type="checkbox"/>	<input checked="" type="checkbox"/>
	2.8	110	$0,006 \times d_1$	90	$0,005 \times d_1$	120	$0,006 \times d_1$	140	$0,004 \times d_1$			<input type="checkbox"/>	<input checked="" type="checkbox"/>
	3.1												
	3.2												
4.1													
4.2													
4.3													
4.4													
5.1													
5.2													
5.3													
S	1.1	120	$0,008 \times d_1$	110	$0,007 \times d_1$	140	$0,009 \times d_1$	160	$0,006 \times d_1$			<input type="checkbox"/>	<input checked="" type="checkbox"/>
	1.2	90	$0,007 \times d_1$	80	$0,006 \times d_1$	100	$0,008 \times d_1$	120	$0,005 \times d_1$			<input type="checkbox"/>	<input checked="" type="checkbox"/>
	1.3	60	$0,006 \times d_1$	50	$0,006 \times d_1$	70	$0,007 \times d_1$	80	$0,005 \times d_1$			<input type="checkbox"/>	<input checked="" type="checkbox"/>
	2.1	90	$0,007 \times d_1$	80	$0,006 \times d_1$	100	$0,008 \times d_1$	110	$0,005 \times d_1$			<input type="checkbox"/>	<input checked="" type="checkbox"/>
	2.2	40	$0,006 \times d_1$	30	$0,005 \times d_1$	50	$0,006 \times d_1$	50	$0,004 \times d_1$			<input type="checkbox"/>	<input checked="" type="checkbox"/>
	2.3	30	$0,005 \times d_1$	30	$0,004 \times d_1$	30	$0,005 \times d_1$	40	$0,004 \times d_1$			<input type="checkbox"/>	<input checked="" type="checkbox"/>
	2.4	40	$0,006 \times d_1$	30	$0,005 \times d_1$	50	$0,006 \times d_1$	50	$0,004 \times d_1$			<input type="checkbox"/>	<input checked="" type="checkbox"/>
2.5	20	$0,005 \times d_1$	20	$0,004 \times d_1$	30	$0,005 \times d_1$	30	$0,004 \times d_1$			<input type="checkbox"/>	<input checked="" type="checkbox"/>	
2.6	30	$0,004 \times d_1$	30	$0,004 \times d_1$	30	$0,005 \times d_1$	40	$0,003 \times d_1$			<input type="checkbox"/>	<input checked="" type="checkbox"/>	
H	1.1												
	1.2												
	1.3												
	1.4												
	1.5												

v_c = Schnittgeschwindigkeit · Cutting speed
 f_z = Vorschub pro Zahn · Feed per tooth

■ = sehr gut geeignet · very suitable
□ = gut geeignet · suitable

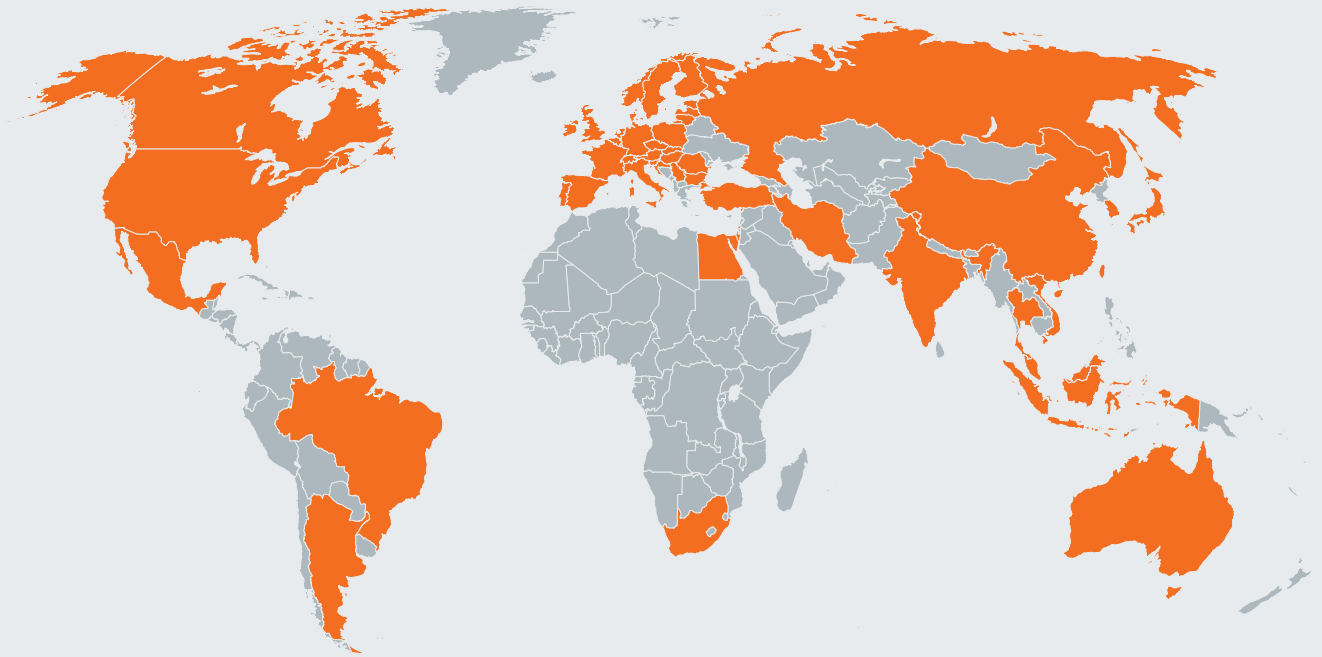

EMUGE-FRANKEN Vertriebspartner finden Sie auf www.emuge-franken.com/vertrieb
EMUGE-FRANKEN sales partners, please see www.emuge-franken.com/sales

EMUGE-Werk Richard Glimpel GmbH & Co. KG
Fabrik für Präzisionswerkzeuge

🏠 Nürnberger Straße 96-100
91207 Lauf
GERMANY

☎ +49 9123 186-0
📠 +49 9123 14313

FRANKEN GmbH & Co. KG
Fabrik für Präzisionswerkzeuge

🏠 Frankenstraße 7/9a
90607 Rückersdorf
GERMANY

☎ +49 911 9575-5
📠 +49 911 9575-327

✉ info@emuge-franken.com 🌐 www.emuge-franken.com